

See
initial set-up
instructions on page one



**COMMERCIAL
PRODUCTS™**

Log Skidder

3-Point Hitch

Model SB-03



Owner / Operator and Safety Manual



**COMMERCIAL
PRODUCTS™**

Iron & Oak Commercial Products, Inc.
410 W. Broadway Ave.
Streator, Illinois 61364-0577
Phone: 815-672-8596
Fax: 815-672-9073
E-mail: sales@logsplitters-ironoak.com
Web Site: www.logsplitters-ironoak.com

SB-03-02
09/03

 Made in U. S. A.

Initial Set-up Instructions

- Read all assembly, operating, and safety instructions.
- Complete and return the warranty card to register your log skidder.
- Write the serial number and date-of-purchase in this manual.
- Assemble the log skidder.
- Obtain and hookup the proper high-pressure hoses that work with your particular utility/garden tractor.
- Obtain and hookup the proper high-pressure hoses that work with your particular utility/garden tractor.
- Make sure the tractor's hydraulic pressure dose not exceed 3,000 PSI. If it does, contact Iron and Oak before attempting to install or operate the log skidder.

NOTE: Iron and Oak Commercial Products reserves the right to make technical changes for product improvement. This manual may contain illustrations and photographs, for demonstration purposes, which slightly deviate from the actual product design.

Serial Number _____

Date-of-Purchase _____

Please enter the serial number and purchase date of your log skidder in the space provided. Keep this manual for future reference.



Contents

Introduction	4
Safety	5
Personal Protection	5
Worksite Safety	5
Operating Safety	6
Log Handling Safety	7
Maintenance and Repair	8
Assembly Instructions	9
Required Materials	9
Shipping List	9
Unpacking the Crate	9
Assembly Procedure	9
Start-Up Procedure	11
Operation	12
Locking the Grapple into Position	13
Decals	14
Inspection and Maintenance	15
General Maintenance Check (before operating)	15
Specifications	15
Mechanical Specifications	15
Hydraulic Specifications	15
Parts Section	16
Warranty	20
Warranty Card	21

Notes

WARNING



To avoid personal injury or death, carefully read and understand all instructions pertaining to the Iron & Oak log skidder.

Do not attempt to assemble, operate, or maintain our product without fully understanding all our instructions and safety precautions. Do not operate the log skidder unless you read and understand the instructions and warnings in this manual. If any doubt or question arises about the correct or safe method of performing anything found in this or other Iron & Oak manuals, contact your Iron & Oak dealer or call the Sales and Service representatives at our main headquarters. Proper care is your responsibility.

WARNING

Accidents can often be avoided by being alert and recognizing potentially hazardous situations. Any individuals operating, maintaining, or repairing products manufactured by Iron & Oak should have the necessary training, skills, and tools required to perform these functions properly and safely. The safety information in this manual serves as a basic guide in an attempt to prevent injury or death.

Iron & Oak cannot anticipate every possible circumstance that might involve a potential hazard. The warnings in this manual and on the product itself are, therefore, not all inclusive. If tools, procedures, work methods, or operating techniques that are not specifically mentioned by Iron & Oak are used, you must satisfy yourself that they are safe for you and for others. Make sure the log skidder will not be damaged or made unsafe by any operation, lubrication, maintenance, or repair procedures that you choose.

DO NOT proceed, if any doubt arises about the correct or safe method of performing anything found in this or other Iron & Oak manuals. Seek out expert assistance from a qualified person before continuing.

Introduction

The SB-03 Log Skidder attachment is designed for use with small (20 to 60 HP) utility sized tractors with hydraulic operating pressures up to 3,000 psi. With up to 2,000 pounds of lifting capacity, depending on the size of the tractor, this attachment will meet the needs of most small operations requiring a log skidder. The log skidder pivots up to 135° in both directions for easy maneuvering and the grapple locks in a 90° position for convenient pick-and-place loading. A heavy-duty, torsion spring always returns the grapple to a center position when the load is released. An attractive powder-coated finish provides the finest protection available, and Iron & Oak's rigid, quality-control and component testing help ensure years of productive, reliable service. Since 1982, the name Iron & Oak has stood for quality and reliability when it comes to wood processing products.

Iron & Oak offers the finest log skidder attachment on the market today!

- ✓ Recommended for tractor size (20 to 60 HP range) with front weights advised for smaller tractors.
- ✓ Designed to operate with hydraulic operating pressure up to 3,000 PSI. If your tractor-supplied pressure exceeds 3,000 PSI, contact Iron & Oak.
- ✓ Fits category 1, 2, and 3 tractor hitches.
- ✓ Rugged, heavy-duty construction for years of exceptional service.
- ✓ All pivot points have composite bearings that never need lubrication.
- ✓ Rigid, quality-control during manufacturing ensures greater reliability.
- ✓ Factory testing of all major components.
- ✓ Powder-coated finish for the best appearance and weather protection.
- ✓ Year-round manufacturing, parts, and support.

For additional information, contact us at:

Iron & Oak Commercial Products, Inc.
410 W. Broadway Ave.
Streator, Illinois 61364-0577
Phone: (815) 672-8596
Fax: (815) 672-9073
E-mail: sales@logsplitters-ironoak.com
Web Site: www.logsplitters-ironoak.com

Important Warranty Information

To activate your iron & oak log skidder warranty, please fill out the information in the form below, clip out the form on the dotted line, insert into an envelope, and mail to:

Iron & Oak Commercial Products, Inc
410 W. Broadway Ave.
Streator, IL 61364-0577

Iron & Oak Log Skidder Warranty Information

- Please Print -

Model: **SB-03** SERIAL #: _____

OWNER'S NAME: _____

ADDRESS: _____

CITY: _____ STATE: _____ ZIP: _____

Purchased From: _____

Street Address: _____

City: _____ State: _____ Zip: _____

Your Signature: _____ Date: _____

Warranty

For one year from the date of purchase, Iron & Oak Commercial Products Inc. will replace for the original purchaser, or repair free of charge, all parts of the Iron & Oak Hydraulic Log Skidder, returned to our factory PREPAID and found upon inspection by us to be faulty, due to defects in materials or workmanship.

The warranty shall not apply to any unit which has been overloaded or misused or which has been installed, used, or operated contrary to our instructions, or which has been repaired or altered by anyone other than our authorized representative.

We shall not be liable for any contingent liabilities arising out of the improper function of any parts.

We make NO WARRANTY with respect to parts NOT of our manufacture, but we will carry out the terms of the warranties of their respective manufacturers.







For commercial and rental use the warranty period is for 30 days from date of purchase.

If a service representative cannot be found in your area, call Iron & Oak at (815) 672-8596. Have your model and serial number on hand before calling.





Safety

The following is a list of safety rules you must follow in order to use your log skidder safely.











Personal Protection

- ✓  To avoid personal injury or death, carefully read and understand all instructions pertaining to the log skidder.
- ✓      Always wear protective gear, such as safety goggles, tight-fitting gloves without draw strings or loose cuffs, steel-toed shoes, and a protective hearing device.
- ✓  To prevent injury, make sure all decals are attached to the log skidder and are legible at all times.

Worksite Safety







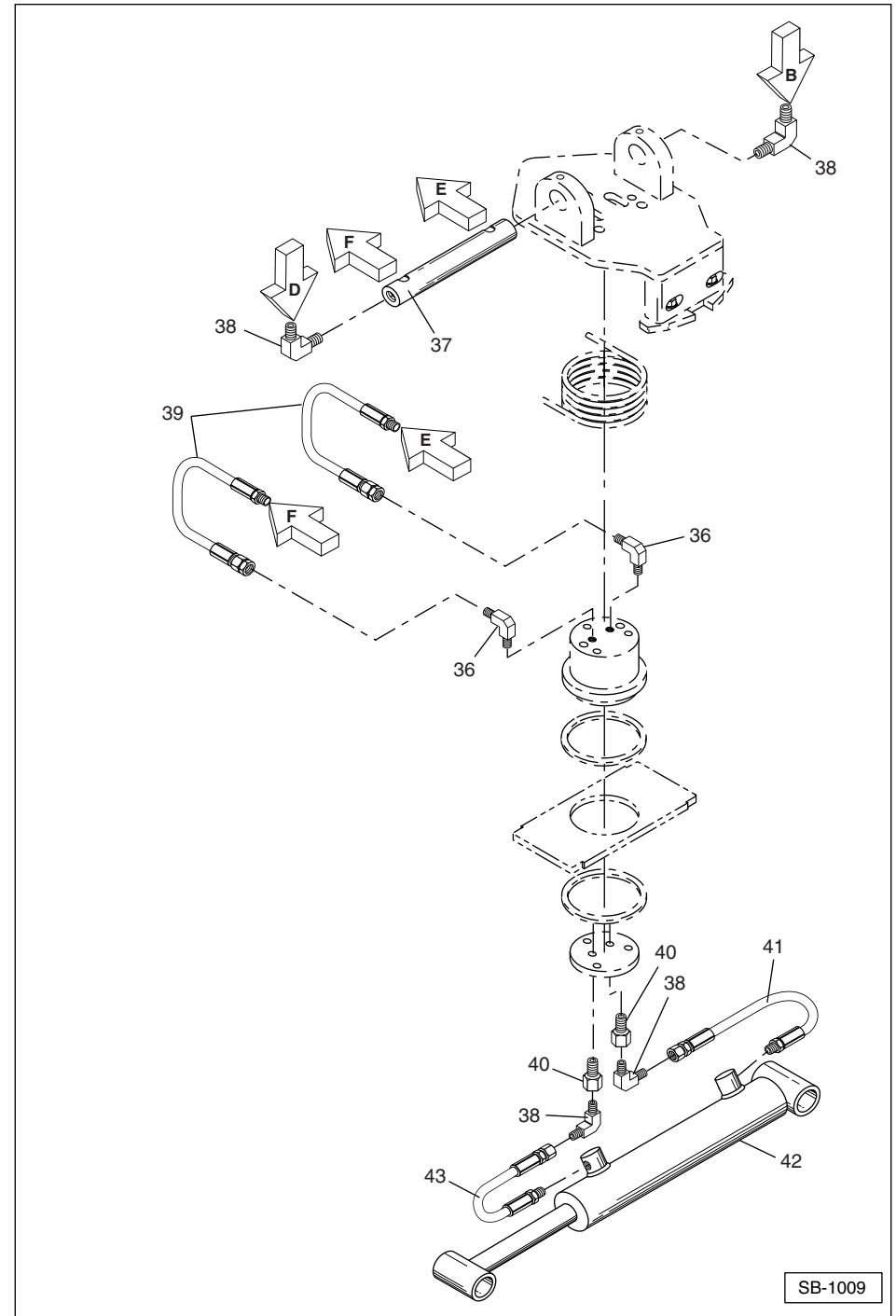

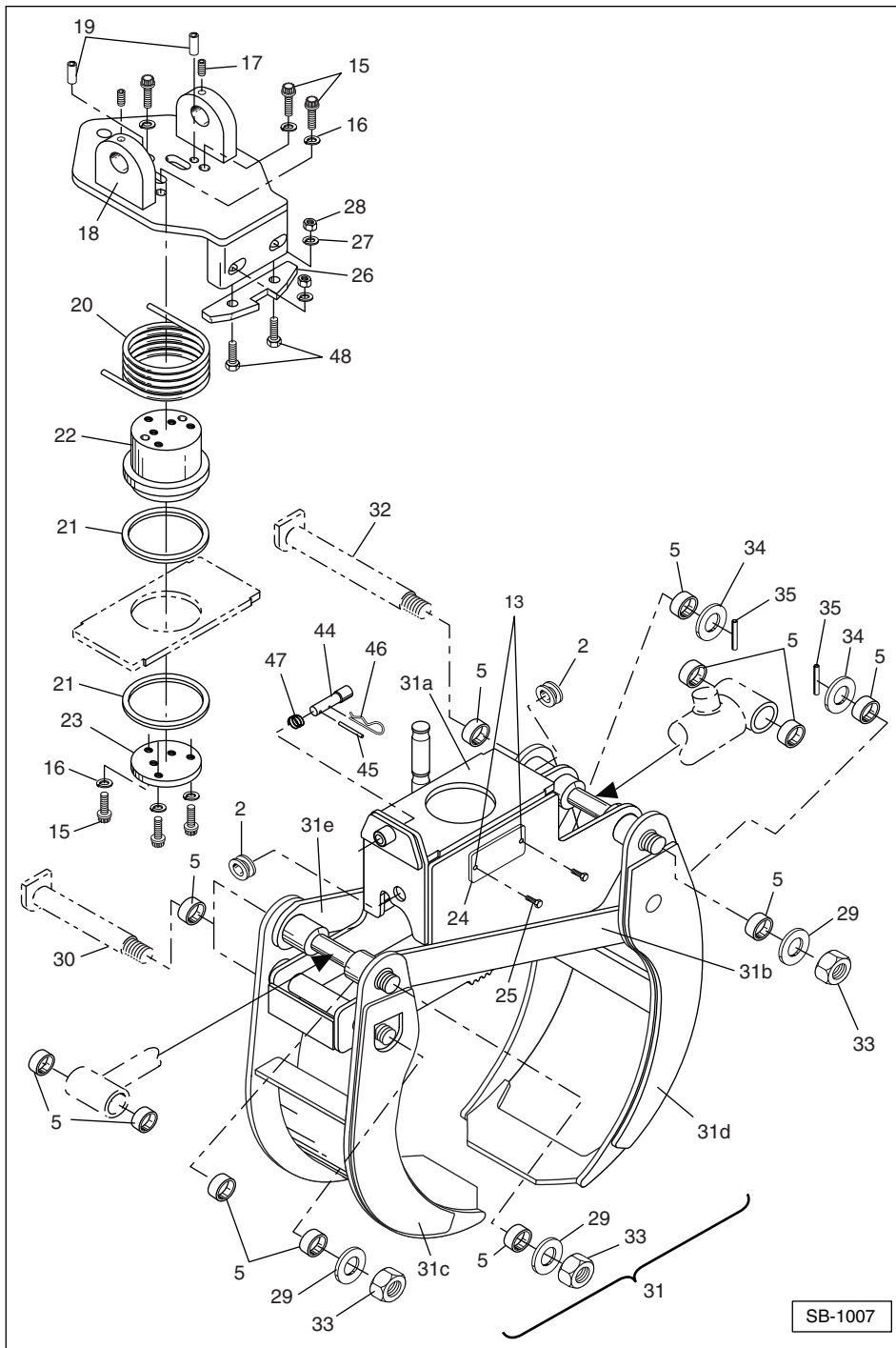
- ✓  To avoid tripping, do not leave tools, logs, or other components laying around the work area.
- ✓  Lower the tubular legs and place the log skidder in a safe position before disengaging the 3-point hitch. Serious injury or death may result from disengaging the log skidder when it is in an unstable position.
- ✓  Sudden movement or accidental starting of the tractor can cause personal injury or death to persons on or near the tractor. When working on or near the tractor, park the tractor on a smooth level surface, stop the engine, and engage the parking brake.
- ✗  NEVER operate your log skidder on slippery, wet, muddy, or icy surfaces.
- ✗  NEVER operate the engine of the tractor in an enclosed area. Exhaust fumes contain carbon monoxide that can be deadly when inhaled. Make sure the area is well ventilated.

Operating Safety







- ✓  ALLOW ONLY ONE (1) PERSON TO OPERATE THE LOG SKIDDER.
- ✓  Allow only adults to operate the log skidder. No one under the age of 18 should be allowed to operate the log skidder.
- ✓  Always keep bystanders, including children and pets, at least twenty-five (25) feet away from the work area.
- ✓  Personal injury or death can result from not engaging the tractor's parking brake while attaching the log skidder. If the parking brake is not engaged, the tractor may roll while you are on or near the tractor. Always engage the parking brake before leaving the tractor.
- ✓  Personal injury could result from improperly coupled attachments. Be certain draft links, top link, and hitch pins are fully engaged on both sides before using the attachment.
- ✓  An improperly installed attachment could become dislodged from the tractor during operation. This could cause injury or death. Do not operate the tractor until you are sure the log skidder attachment is properly connected.
- ✓  For tractors equipped with quick disconnect couplings, improper attachment of the hoses could result in injury or death. Do not operate this tractor until you are sure that the quick disconnect couplings are fully engaged.
- ✓  Heavy 3-point hitch mounted equipment reduces road stability, regardless of the amount of front counterweight added. Insufficient roading stability can lead to an accident, causing personal injury and property damage. Reduce speed when encountering rough terrain or whenever the tractor's directional stability is reduced.
- ✗  Do not allow any person to operate the log skidder until they have read and understood the safe operating instructions contained in this manual and the tractor's manuals.
- ✗  Never exceed the rated load. This can cause possible personal injury or attachment damage. Do not exceed the maximum 2000 pound rated load of this attachment while performing any operation. Make adjustments to the rated load as necessary, depending on the size of the tractor.
- ✗  Machine instability can result in injury or death. To ensure stability during operation do not overload the tractor and follow all the tractor's manufacturers safety recommendations.

















- ✘  Do not, under any circumstances, alter your log skidder. This equipment was designed and engineered to be used in accordance with the operating instructions. Altering the equipment, or using the equipment in such a way as to circumvent its design capabilities and capacities, could result in serious or fatal injury and WILL VOID THE WARRANTY.
- ✘  Never operate, or allow anyone else to operate, this equipment while under the influence of medication, drugs, or alcohol.
- ✘  Never wear loose clothing or jewelry that may get caught or become entangled in the log skidder.
- ✘  NEVER place hands or feet between the log and the grapple.
- ✘  DO NOT ALLOW SOMEONE TO STRADDLE OR REACH ACROSS THE LOG WHEN OPERATING THE LOG SKIDDER.
- ✘  Only use your hands to operate the tractor's control lever. NEVER use your foot, knee, a rope, or any other extension device.
- ✘  Improper skidder operation can cause personal injury or death.
- ✘  Personal injury can result from turning on a steep grade.

Log Handling Safety

- ✓  When maneuvering a log, ALWAYS position the tractor so that the jaws of the grapple are directly over the log.
- ✓  ALWAYS allow sufficient clearance between the front end of the log (nearest the tractor) and the skidder frame/tractor to prevent any contact while pivoting.
- ✓  ALWAYS get a firm grip on the log you plan to carry.
- ✓  Use extra caution when crossing side hills, ridges, other logs, and/or ditches. Never make quick directional shifts or fast stops.
- ✓  Pulling logs at a sharp angle can cause the tractor to tip. To avoid injury, always pull in a straight line behind the tractor.
- ✓  Be sure all personnel are clear of the log when it is being lowered or transported. Failure to stay clear of the log may result in personal injury.

- ✓  Carry the load as low as possible. Do not exceed the rated 2,000 pound load. Load, unload, and turn on level ground. Travel up and down slopes with the heaviest end of the load uphill. Failure to follow the instructions or heed the warnings could result in injury or death.
- ✗  NEVER swivel the grapple beyond the 135° pivot angle in either direction when making sharp turns. Pivoting beyond this limit could damage the torsion spring and hydraulic lines and put undue stress on the tractor components.
- ✗  NEVER back up while holding a log. This practice could cause damage to the skidder or the tractor.
- ✓  ALWAYS raise the log sufficiently off the ground so it can be skidded easily without digging into the ground. Note, the height will depend largely on the size of the tractor.
- ✗  Injury to persons can result from logs being moved by the log skidder. Make sure all persons are clear of the logs before moving the tractor. The tail end of the tree length logs can throw objects at bystanders.
WARNING: To avoid bodily injury, do NOT allow anyone to stand near the log skidder at any time the unit is in operation or while it is holding a log.

Maintenance and Repair

- ✓  Follow all safety rules, because most accidents involving the operation, maintenance, or repair of products occur because the assembler/owner/operator failed to observe basic safety rules or operating instructions.
- ✓  ALWAYS inspect your log skidder before each use. Make sure all nuts, bolts, screws, hydraulic fittings, hose clamps, etc. are securely tightened.
- ✓  ALWAYS check the oil level in the hydraulic oil tank of the tractor.
- ✗  NEVER operate your log skidder when it is in need of repair or is in poor mechanical condition.
- ✗  NEVER make alterations to your log skidder in any manner. Such alterations may cause the log skidder to become unsafe and WILL VOID THE WARRANTY.
- ✗  NEVER attach a rope or extension to the tractor's control levers. Such ALTERATIONS may cause the log skidder to become UNSAFE.
- ✗  ALWAYS clean the unit after each use. If possible, store the unit inside or cover it completely, if stored outside.

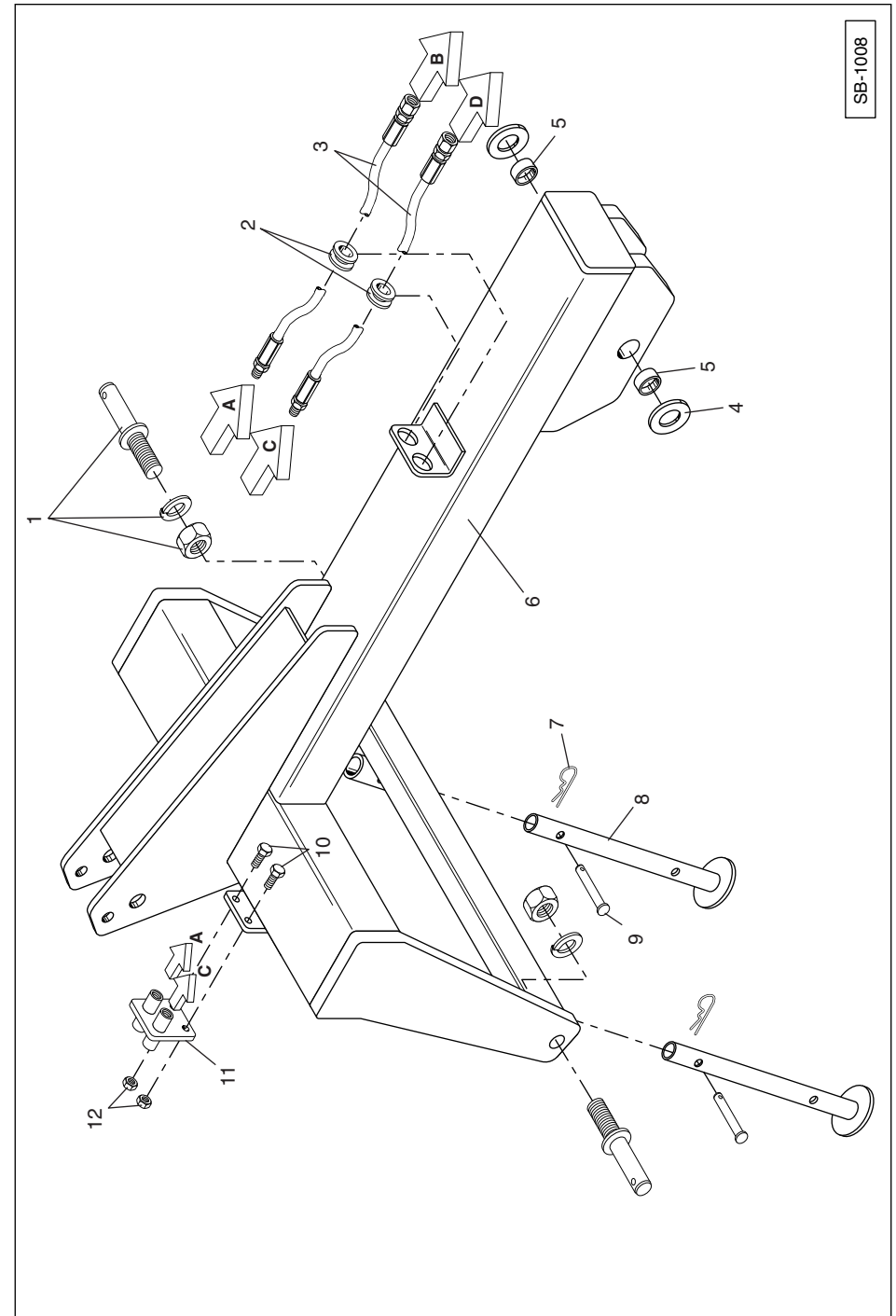

Parts Section

Item	Part No.	Description	Qty
1	BR001703	Pin Assembly, Lift Arm	2
2	BR001032	Grommet	4
3	BR005050	High-Pressure Hose, 47" long	2
4	BR017029	Thrust Washer	2
5	BR001047	Bushing, Phenolic	18
6	BR04000F-03	Frame Weldment	1
7	BR001761	Clip, Hairpin (Legs)	2
8	BR04000F-LA	Support Leg	2
9	BR001493	Pin, Clevis (Legs)	2
10	BR001251	Bolt, 3/8-16 x 1.5 long	2
11	BR04000-BP-03	Plate Assembly, Bolt-on	1
12	BR001301	Locknut, 3/8-16	2
13	BR001325	Locknut, 5/16-18	2
14	—	—	—
15	BR001210	Bolt (12-Point Socket) Flange Head, 5/8-18 x 2.0 long	6
16	BR001399	Lockwasher	6
17	BR001385	Setscrew, 1/2-13 x 0.5 long	2
18	BR04000C-CM-03	Mount, Assembly (Claw)	1
19	BR001298	Roll Pin	2
20	BR008149	Spring, Torsion	1
21	BR040096	Hub Bearing	2
22	BR040123	Hub	1
23	BR040122	Lock Plate, Hub	1
24	BR040098	Access Cover	1
25	BR001202	Bolt, 5/16-18 x 1" long	2
26	BR040093	Latch Plate	1
27	BR001405	Flat Washer, 1/4"	2

Assembly Instructions

Required Materials

Purchase or manufacture two high-pressure hydraulic hoses (3000 psi minimum). These hoses must be long enough to connect from the tractor's hydraulic connections to the 1/2 inch NPT fittings on the log skidder. The type, size, and pressure rating of the owner supplied hydraulic hoses must be determined by the owner using the tractor's specifications. The hoses can be fitted with quick disconnect fittings, if desired.

Shipping List

The following chart contains the list of parts that should be shipped as part of the SB-03 Log Skidder.

Qty	Description
1	Log Skidder
2	Legs with Hitch Pins
2	Lift Arm Pin Assemblies

Unpacking the Crate

1. Cut the metal banding around the packing crate and remove the top, sides, ends, and protective plastic covering. Do not unband or remove the log skidder from the bottom pallet at this time.
2. Carefully check the log skidder on the crate for shipping damage. If the parts are damaged call Iron & Oak at (815) 672-8596.

Assembly Procedure

 **CAUTION**

The log skidder is very heavy and can be damaged if mis-handled. Also, to help prevent personal injury, it is strongly recommended that two (2) people work together to uncrate the log skidder.

1.  Read all instructions and safety recommendations in this booklet before assembling or operating this log skidder attachment.
2. Cut the bands holding the log skidder onto the pallet.

- Using a lifting device, lift the log skidder off the pallet and install the two pipe legs. Secure the legs in the standing position with the clevis pins and hairpin clips.
- Remove the lift arm pins from the parts box and install them, as shown.



NOTE: Attach the log skidder to the three-point hitch of your tractor using the instructions in your tractor manual and/or follow these general instructions.

- Position the tractor in front of the log skidder so the hitch points align. Place the transmission in neutral (N) position, stop the engine, and engage the brakes BEFORE leaving the tractor seat.
- Be sure the drawbar does not interfere. If necessary, move the drawbar ahead, or remove it. Check for any other potential interference.
- Slide the lift arms over the log skidder lift arm pins. Lock the lift arms in position using the hairpin clip.
- Attach the center link bar to the center link pin. Adjust the center link and lift arms as necessary.
- Remove the factory installed pipe plugs and hook up the owner-supplied hydraulic hoses (1). Refer to the Assembly Instructions, Required Materials section in this manual for hose specifications.

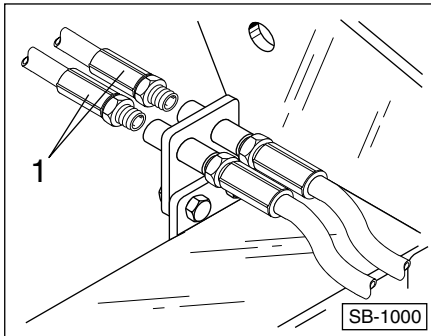

⚠ WARNING

To avoid personal injury or damage to the hydraulic components, do not use the SB-03 Log Skidder with tractor-supplied pressures that exceed 3,000 PSI.

⚠ CAUTION



To avoid bodily injury or machine damage whenever an attachment is connected to the tractor's 3-point hitch, check the full range of operation for interference or binding.

Inspection and Maintenance

General Maintenance Check (before operating)

The hydraulic system (hoses, hose connection, rotating unit, etc.) should be carefully inspected before each use. Also, inspect the mechanical parts at the same time. Make sure all clamps, nuts, bolts, fittings, etc. are properly installed and tightened.

⚠ WARNING



Do not check for leaks with your hand. Leaks can be located by passing a piece of cardboard or wood around the suspected leak and looking for discoloration. High-pressure fluid escaping from a very small hole can be almost invisible. Escaping fluid under pressure can have sufficient force to penetrate skin, causing serious injury or even death. If fluid is injected into your skin, it must be treated immediately by a doctor familiar with this type of injury.

Always replace frayed, kinked, or cracked hoses and/or other damaged hydraulic components with Iron & Oak authorized parts and components specified in the "Parts" section of this manual. Replacement parts from secondary suppliers (not original Iron & Oak replacement parts) can lead to product damage and/or personal injury, and will void the warranty.

Should it become necessary to loosen or remove any hydraulic fitting or hose, be sure to relieve all hydraulic pressure (see tractor's owner/operator manual).

Specifications

Mechanical Specifications

Maximum grapple opening	55 inches
Maximum log diameter	36 inches
Maximum lifting capacity	2000 lbs. (depends on size of tractor)

Hydraulic Specifications

Hook up fittings	1/2 inch NPT
Recommended tractor size	20 to 60 HP
Hydraulic operating pressure	not to exceed 3,000 PSI

Note: If your tractor's hydraulic pressure exceeds 3,000 PSI, contact Iron and Oak before attempting to install or operate the log skidder.

3-Point hitch	Category 1, 2, or 3
Pivot (swing) angle	135° in each direction
Unit weight	450 lbs.
Overall shipping size (H x W x L)	34.5 x 31.5 x 81.0 inches

Decals

(1)



(2)

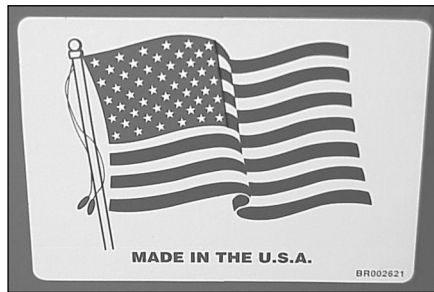

(3)



(4)

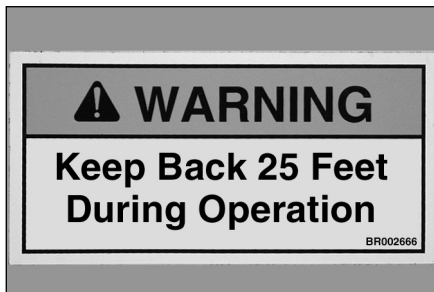

Item	Part No.	Description	Qty.
1	BR002521	Decal, Serial Number	1
2	BR002621	Decal, Flag	1
3	BR002667	Decal, Log Skidder	2
4	BR002666	Decal, Keep Back	1

Start-up Procedure

1. Start the tractor. Make sure the parking brake is engaged and the tractor is in Neutral.
2. Raise the log skidder and place the round tubular legs in the upper storage position.
3. Lower and raise the log skidder slowly and check for any point(s) of interference.

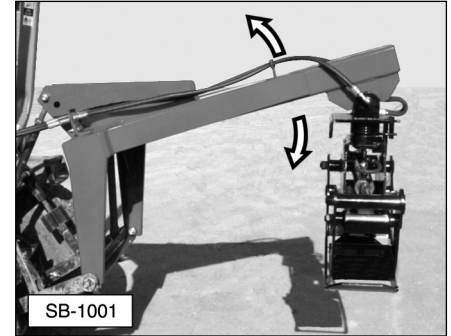

4. Operate the tractor's control lever(s) to slowly open and close the grapple, making sure it operates properly.

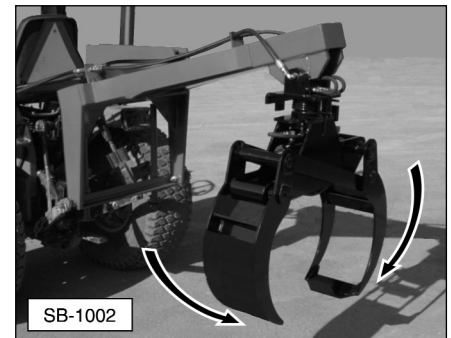
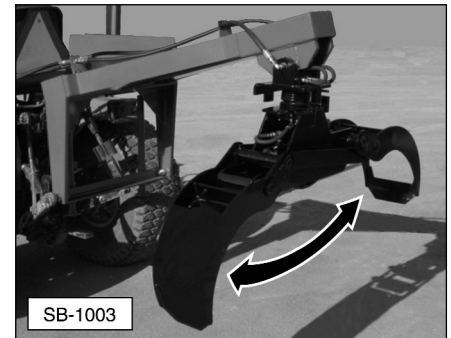

5. Check all hydraulic connections for leaks. Tighten as needed.

Operation

WARNING



Do not attempt to operate the log skidder without fully understanding all our instructions, safety precautions, and/or warnings and those of the tractor. If any doubt or question arises about the correct or safe method of performing anything found in this or other Iron & Oak manuals, contact your Iron & Oak's dealer or call the Sales and Service representatives at our main headquarters. Proper care is your responsibility.

1. Use the tractor's operation manual to determine the levers that open and close the grapple.

2. Position the grapple over the log and close the grapple. Do not try to pick up or skid logs heavier than the capacity of the tractor being used.



3. Pull the log to where you want it. Do not back up while holding a log. This may cause damage to the log skidder attachment and/or the tractor.

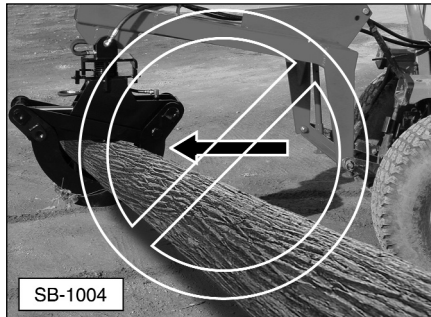

4. Allow 4 to 5 inches of clearance under the log when opening the grapple. If the grapple is on the ground when it is opened the grapple fingers may dig into the ground, causing them not to open.

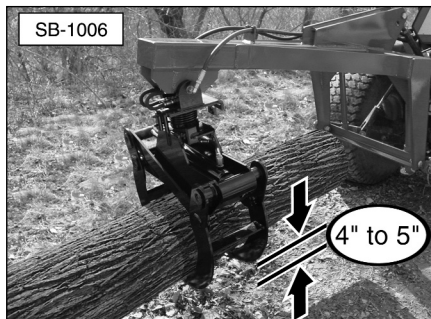

Locking the Grapple into Position

This procedure allows the grapple to be locked in the 90° position for pick-and-place loading.

WARNING

The 90° locking feature is intended for pick-and-place loading only. The lock plate is held in position with 1/4" bolts, designed to shear when excessive torque loads occur. This safety feature is intended to prevent damage to the grapple. Replacement bolts must be Grade 5.

1. Turn off the engine and apply the parking brake on the tractor.

2. Pull out on the spring-loaded lock pin and remove the hairpin clip.

3. With the grapple open or closed, rotate it 90° until the lock pin snaps into the lock plate.

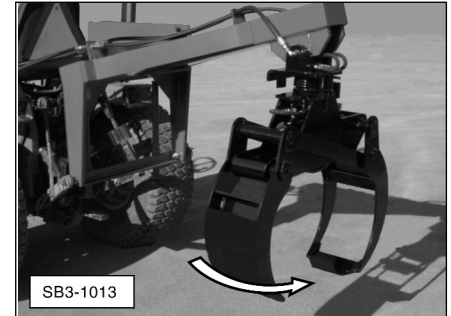

4. Insert the hairpin clip into the spring pin on the end of the lock pin (stored position), as shown.

5. When operating the Skidder-Loader with the grapple locked in the 90° position, balance the load evenly from side-to-side to make sure you are operating in a safe manner. An unbalanced load may cause the skid steer loader to lean or tip.



6. During normal use of the log skidder, pull the lock pin out and insert the hairpin clip, as shown. This will prevent the lock pin from engaging with the lock plate.

7. Follow all other operating instructions in the "Operation" section of this manual.

