



**COMMERCIAL
PRODUCTS™**

*See
initial set-up
instructions on page one*

Skidder-Loader

for Skid Steer Loaders

Model SL-03



Owner / Operator and Safety Manual

Initial Set-up Instructions

- ❑ Read all connecting, operating, and safety instructions.
- ❑ Complete and return the warranty card to register your Skidder-Loader.
- ❑ Write the serial number and date-of-purchase in this manual.
- ❑ Obtain and hook up the proper high-pressure hoses that work with your particular skid steer loader.
- ❑ Make sure the skid steer loader's hydraulic pressure does not exceed 3,000 PSI. If it does, contact Iron and Oak before attempting to install or operate the Skidder-Loader.

NOTE: As you read this manual, the term “Skidder-Loader” refers to the Iron & Oak attachment, while the term “skid steer loader” refers to the actual machine which holds our “Skidder-Loader” attachment. Also, the term “Skidder-Loader,” referring to the attachment, will always be capitalized.

NOTE: Iron and Oak Commercial Products reserves the right to make technical changes for product improvement. This manual may contain illustrations and photographs, for demonstration purposes, which slightly deviate from the actual product design.

Serial Number _____

Date-of-Purchase _____

Please enter the serial number and purchase date of your Skidder-Loader in the space provided. Keep this manual for future reference.



The image shows a rectangular warranty card with a metallic or embossed appearance. On the left side, there is a logo for "IRON & OAK" in a stylized font. To the right of this logo, the text "BRAVE PRODUCTS, INC." is printed in a bold, sans-serif font, with "Streator, IL" underneath it. On the far right, there is a graphic of a tree. At the bottom left, the words "SERIAL No." are printed above a rectangular box intended for the user to write the serial number. At the bottom center, the text "Made in U.S.A." is printed.

Contents

Introduction	4
Safety	5
Personal Protection	5
Worksite Safety	5
Operating Safety	6
Log Handling Safety	7
Maintenance and Repair	8
Connecting Instructions	9
Required Materials	9
Unpacking the Pallet	9
Connecting Procedure	9
Start-Up Procedure	11
Operation	12
Locking the Grapple into Position	14
Decals	15
Inspection and Maintenance	16
General Maintenance Check (before operating)	16
Specifications	16
Mechanical Specifications	16
Hydraulic Specifications	16
Parts Section	17
Warranty Card	21
Warranty	23

WARNING



To avoid personal injury or death, carefully read and understand all instructions pertaining to the Iron & Oak Skidder-Loader.

Do not attempt to connect, operate, or maintain our product without fully understanding all our instructions and safety precautions. Do not operate the Skidder-Loader attachment unless you read and understand the instructions and warnings in this manual. If any doubt or question arises about the correct or safe method of performing anything found in this or other Iron & Oak manuals, contact your Iron & Oak dealer or call the Sales and Service representatives at our main headquarters. Proper care is your responsibility.

WARNING

Accidents can often be avoided by being alert and recognizing potentially hazardous situations. Any individuals operating, maintaining, or repairing products manufactured by Iron & Oak should have the necessary training, skills, and tools required to perform these functions properly and safely. The safety information in this manual serves as a basic guide in an attempt to prevent injury or death.

Iron & Oak cannot anticipate every possible circumstance that might involve a potential hazard. The warnings in this manual and on the product itself are, therefore, not all inclusive. If tools, procedures, work methods, or operating techniques that are not specifically mentioned by Iron & Oak are used, you must satisfy yourself that they are safe for you and for others. Make sure the Skidder-Loader will not be damaged or made unsafe by any operation, lubrication, maintenance, or repair procedures that you choose.

DO NOT proceed, if any doubt arises about the correct or safe method of performing anything found in this or other Iron & Oak manuals. Seek out expert assistance from a qualified person before continuing.

Introduction

The SL-03 Skidder-Loader attachment is designed for use with small (30 to 60 HP) skid steer loaders. With up to 2,000 pounds of lifting capacity, depending on the size of the skid steer loader, this attachment will meet the needs of most small operations requiring a Skidder-Loader. The Skidder-Loader pivots up to 135° in both directions for easy maneuvering and the grapple locks in a 90° position for convenient pick-and-place loading. A heavy-duty, torsion spring always returns the grapple to a center position when the load is released. An attractive, powder-coated finish provides the finest protection available, and Iron & Oak's rigid, quality-control and component testing help ensure years of productive, reliable service. Since 1982, the name Iron & Oak has stood for quality and reliability when it comes to wood processing products.

Iron & Oak offers the finest Skidder-Loader attachment on the market today!

- ✓ Rugged, heavy-duty construction for years of exceptional service.
- ✓ Designed to operate with hydraulic operating pressure up to 3,000 PSI. If your supplied pressure exceeds 3,000 PSI, contact Iron & Oak.
- ✓ All pivot points have composite bearings that never need lubrication.
- ✓ Recommended for skid steer loader size (30 to 60 HP range).
- ✓ Rigid, quality-control during manufacturing ensures greater reliability.
- ✓ Factory testing of all major components.
- ✓ Powder-coated finish for the best appearance and weather protection.
- ✓ Year-round manufacturing, parts, and support.

For additional information, contact us at:

Iron & Oak Commercial Products, Inc.
410 W. Broadway Ave.
Streator, Illinois 61364-0577
Phone: (815) 672-8596
Fax: (815) 672-9073
E-mail: sales@logsplitters-ironoak.com
Web Site: www.logsplitters-ironoak.com





Safety

The following is a list of safety rules you must follow in order to use your Skidder-Loader safely.











Personal Protection







- ✓  Always wear protective gear, such as safety goggles, tight-fitting gloves without draw strings or loose cuffs, steel-toed shoes, and a protective hearing device.
- ✓  To prevent injury, make sure all decals are attached to the Skidder-Loader and are legible at all times.

Worksite Safety







- ✓  To avoid tripping, do not leave tools, logs, or other components laying around the work area.
- ✓  Sudden movement or accidental starting of the skid steer loader can cause personal injury or death to persons on or near the skid steer loader. When working on or near the skid steer loader, park it on a smooth level surface, stop the engine, and engage the parking brake.
- ✗  NEVER operate your skid steer loader with the Skidder-Loader attachment on slippery, wet, muddy, or icy surfaces.
- ✗  Use caution when operating your skid steer loader in an enclosed area. Exhaust fumes contain carbon monoxide which can be deadly when inhaled. Make sure the area is well ventilated.





Operating Safety

- ✓  ALLOW ONLY ONE (1) PERSON TO OPERATE THE SKID STEER LOADER WITH THE SKIDDER-LOADER ATTACHMENT.
- ✓  Allow only adults to operate the Skidder-Loader. No one under the age of 18 should be allowed to operate the Skidder-Loader.
- ✓  Always keep bystanders, including children and pets, at least twenty-five (25) feet away from the work area.
- ✓  Personal injury or death can result from not engaging the skid steer loader's parking brake while attaching the Skidder-Loader. If the parking brake is not engaged, the skid steer loader may roll while you are on or near the skid steer loader. Always engage the parking brake before leaving the skid steer loader.
- ✓  Personal injury could result from an improperly coupled Skidder-Loader. Be certain the pins are fully engaged and locked in place on both sides before using the attachment.
- ✓  An improperly installed attachment could become dislodged from the skid steer loader during operation. This could cause injury or death. Do not operate the skid steer loader until you are sure the Skidder-Loader attachment is properly connected.
- ✓  For skid steer loaders equipped with quick disconnect couplings, improper attachment of the hoses could result in injury or death. Do not operate the skid steer loader until you are sure that the quick disconnect couplings are fully engaged.
- ✓  Heavy attachments may reduce road stability and can lead to an accident, causing personal injury and property damage. Reduce speed when encountering rough terrain or whenever the skid steer loader's directional stability is reduced.
- ✗  Do not allow any person to operate the Skidder-Loader until they have read and understood the safe operating instructions contained in this manual and the skid steer loader's manuals.
- ✗  Never exceed the rated load. This can cause possible personal injury or attachment damage. Do not exceed the maximum 2000 pound rated load capacity of this attachment while performing any operation. Make adjustments to the load as necessary, depending on the size of the skid steer loader.
- ✗  Machine instability can result in injury or death. Make sure all four (4) tires maintain firm footing so the skid steer loader does not tip while lifting or operating.







- ✗  Do not, under any circumstances, alter your Skidder-Loader. This attachment was designed and engineered to be used in accordance with the operating instructions. Altering the attachment, or using the attachment in such a way as to circumvent its design capabilities and capacities, could result in serious or fatal injury and WILL VOID THE WARRANTY.
- ✗  Never operate, or allow anyone else to operate, this attachment while under the influence of medication, drugs, or alcohol.
- ✗  Never wear loose clothing or jewelry that may get caught or become entangled in the Skidder-Loader.
- ✗  NEVER place hands or feet between the log and the grapple.
- ✗  DO NOT ALLOW SOMEONE TO STRADDLE OR REACH ACROSS THE LOG WHEN OPERATING THE SKIDDER-LOADER ATTACHMENT.
- ✗  Improper skid steer loader operation can cause personal injury or death.
- ✗  Personal injury can result from turning on a steep grade.

Log Handling Safety

- ✓  When maneuvering a log, ALWAYS position the skid steer loader so that the jaws of the grapple are directly over the log.
- ✓  ALWAYS get a firm grip on the log you plan to carry.
- ✓  Use extra caution when crossing side hills, ridges, other logs, and/or ditches. Never make quick directional shifts or fast stops.
- ✓  Pulling logs at a sharp angle can cause the skid steer loader to tip. To avoid injury, always pull in a straight line behind the skid steer loader.
- ✓  Be sure all personnel are clear of the log when it is being lowered or transported. Failure to stay clear of the log may result in personal injury or death.
- ✓  Carry the load as low as possible (close to the ground). Do not exceed rated load. Load, unload, and turn on level ground. Failure to follow the instructions or heed the warnings could result in injury or death.

- ✘  Dropping a log from excessive height can cause one end of the log to fall into the cab area striking the operator. The log must be lowered to ground level before releasing.
- ✘  NEVER rotate grapple more than 135° left or right. Pivoting beyond the limit could damage the torsion spring and hydraulic lines and put undue stress on the tractor components.
- ✘  Always drag (pull) the log. Never push it.
- ✓  ALWAYS raise the log sufficiently off the ground so it can be skidded easily without digging into the ground.
- ✘  Injury to persons can result from logs being moved by the Skidder-Loader. Make sure all persons are clear of the logs before moving the skid steer loader, because the tail end of tree length logs can throw objects at bystanders.
WARNING: To avoid bodily injury, DO NOT allow anyone to stand near the Skidder-Loader at any time the unit is in operation or while it is holding a log.

Maintenance and Repair

- ✓  Follow all safety rules, because most accidents involving the operation, maintenance, or repair of products occur because the owner/operator failed to observe basic safety rules and/or operating instructions.
- ✓  ALWAYS inspect your Skidder-Loader before each use. Make sure all nuts, bolts, screws, hydraulic fittings, etc. are securely tightened.
- ✓  ALWAYS check the oil level in the hydraulic oil tank of the skid steer loader.
- ✘  NEVER operate your Skidder-Loader when it is in need of repair or is in poor mechanical condition.
- ✘  NEVER make alterations to your Skidder-Loader in any manner. Such alterations may cause the Skidder-Loader to become unsafe and WILL VOID THE WARRANTY.
- ✘  ALWAYS clean the unit after each use. If possible, store the unit inside or cover it completely, if stored outside.

Connecting Instructions

Required Materials

Purchase or manufacture two high-pressure hydraulic hoses (3000 psi minimum). These hoses must be long enough to connect from the skid steer loader's auxiliary hydraulic connections to the 1/2 inch NPT fittings on the Skidder-Loader. The type, size, and pressure rating of the owner supplied hydraulic hoses must be determined by the owner using the skid steer loader's specifications. Hoses must be long enough to cover the full range of motion without binding. Connect the hoses to the Skidder-Loader using the appropriate fittings.

Unpacking the Pallet

Remove the plastic cover and carefully check the unit for shipping damage. If any parts are damaged, call Iron & Oak at (815) 672-8596.

Connecting Procedure

1.  Read all instructions and safety recommendations in this manual before connecting or operating this Skidder-Loader attachment.
2. Cut the bands holding the Skidder-Loader onto the pallet.
3. The Skidder-Loader can be removed from the pallet using the skid steer loader.
4. Move the attachment arms of the skid steer loader under the lip of the Skidder-Loader connecting plate and lock it in place. If necessary, refer to the OEM manual for additional help.



- Remove the factory installed pipe caps and hook up the owner-supplied hydraulic hoses (1). Refer to the "Connecting Instructions," "Required Materials" section, in this manual for hose specifications.

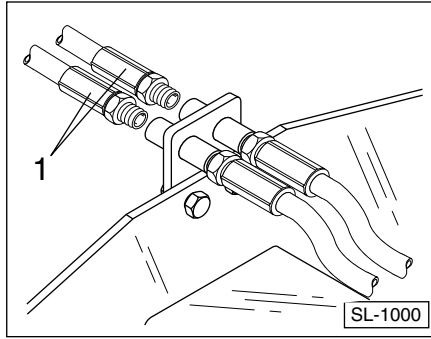

⚠ WARNING

To avoid personal injury or damage to the hydraulic components, do not use the SL-03 Skidder Loader with pressures that exceed 3,000 PSI.

⚠ CAUTION



To avoid bodily injury or machine damage whenever an attachment is connected to the skid steer loader, check the full range of operation for interference or binding.

Start-up Procedure

- Start the skid steer loader.
- Operate the skid steer loader's control lever(s) to slowly raise, lower, open, and close the grapple, making sure it operates properly.

NOTE: Check to make sure the hoses are long enough to cover the full range of motion and that they are not binding. If so, replace with longer hoses.



- Check all hydraulic connections for leaks. Tighten as needed.

Operation

⚠ WARNING



Do not attempt to operate the Skidder-Loader without fully understanding all our instructions, safety precautions, and/or warnings and also those of the skid steer loader. If any doubt or question arises about the correct or safe method of performing anything found in this or other Iron & Oak manuals, contact your Iron & Oak's dealer or call the Sales and Service representatives at our main headquarters. Proper care is your responsibility.

1. Use the skid steer loader's operation manual to determine the levers required to raise, lower, open, and close the grapple. Practice using these controls before handling any logs or trees.

2. Maneuver the skid steer loader to position the grapple over the log or tree, then lower and close the grapple. Lift the log sufficiently off the ground, so the end does not dig into the soil while skidding. Do not try to pick up or skid logs heavier than the capacity of the Skidder-Loader or the skid steer loader being used.



3. Pull the log to desired location. Never push a log, as this procedure may damage the Skidder-Loader attachment or the skid steer loader. Raise or lower the log, as necessary, for best stability and visibility.



4. To release the log or tree, allow 4 to 5 inches of clearance under the log, then open the grapple. Use caution, so the grapple fingers do not dig into the ground. If you are stacking trees or logs and need to open the grapple in the raised position, use caution, as the sudden release may cause the skid steer loader to jerk or tip.



⚠ WARNING



Dropping a log from excessive height can cause one end of the log to fall into the cab area striking the operator. The log must be lowered to ground level before releasing.

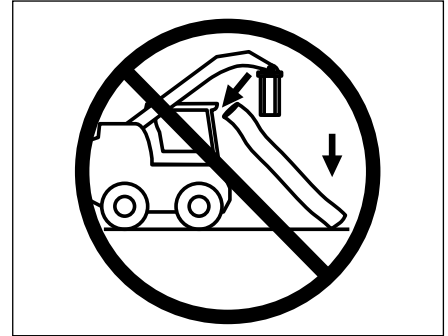

Locking the Grapple into Position

This procedure allows the grapple to be locked in the 90° position for pick-and-place loading.

! WARNING

The 90° locking feature is intended for pick-and-place loading only. The lock plate is held in position with 1/4" bolts, designed to shear when excessive torque loads occur. This safety feature is intended to prevent damage to the grapple. Replacement bolts must be Grade 5.

1. Turn off the engine and apply the parking brake on the skid steer loader.
2. Pull out on the spring-loaded lock pin and remove the hairpin clip.
3. With the grapple open or closed, rotate it 90° in either direction until the lock pin snaps into the lock plate.



4. Insert the hairpin clip into the spring pin on the end of the lock pin (stored position), as shown.
5. When operating the Skidder-Loader with the grapple locked in the 90° position, balance the load evenly from side-to-side to make sure you are operating in a safe manner. An unbalanced load may cause the skid steer loader to lean or tip.



6. During normal use of the Skidder-Loader, pull the lock pin out and insert the hairpin clip, as shown. This will prevent the lock pin from engaging with the lock plate.



7. Follow all other operating instructions in the "Operation" section of this manual.

Decals

(1)



(2)

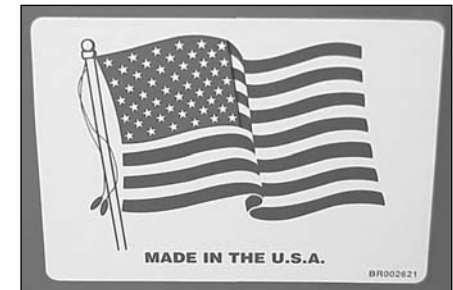

(3)

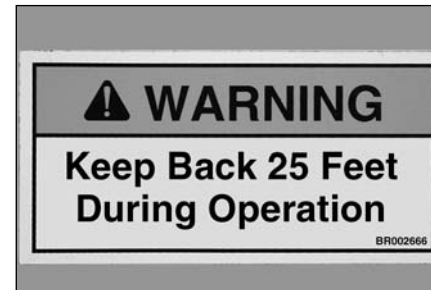

(4)



Item	Part No.	Description	Qty.
1	BR002521	Decal, Serial Number	1
2	BR002621	Decal, Flag	1
3	BR002666	Decal, Keep Back	1
4	BR002668	Decal, Skidder Loader	2

Inspection and Maintenance

General Maintenance Check (before operating)

The hydraulic system (hoses, hose connection, rotating unit, etc.) should be carefully inspected before each use. Also, inspect the mechanical parts at the same time. Make sure all clamps, nuts, bolts, fittings, etc. are properly installed and tightened.

WARNING



Do not check for leaks with your hand. Leaks can be located by passing a piece of cardboard or wood around the suspected leak and looking for discoloration. High-pressure fluid escaping from a very small hole can be almost invisible. Escaping fluid under pressure can have sufficient force to penetrate skin, causing serious injury or even death. If fluid is injected into your skin, it must be treated immediately by a doctor familiar with this type of injury.

Always replace frayed, kinked, or cracked hoses and/or other damaged hydraulic components with Iron & Oak authorized parts and components specified in the "Parts" section of this manual. Replacement parts from secondary suppliers (not original Iron & Oak replacement parts) can lead to product damage and/or personal injury, and will void the warranty.

Should it become necessary to loosen or remove any hydraulic fitting or hose, be sure to relieve all hydraulic pressure (see skid steer loader's owner/operator manual).

Specifications

Mechanical Specifications

Maximum grapple opening 55 inches
 Maximum log diameter 36 inches
 Maximum lifting capacity 2000 lbs. (depends on size of skid steer loader)

Hydraulic Specifications

Hook up fittings 1/2 inch NPT
 Recommended skid steer loader size 30 to 60 HP
 Hydraulic operating pressure not to exceed 3,000 PSI

Note: If your skid steer loader's hydraulic pressure exceeds 3,000 PSI, contact Iron and Oak before attempting to install or operate the log skidder.

Pivot (swing) angle 135° in each direction
 Unit Weight 650 lbs.

Parts Section

Item	Part No.	Description	Qty
1	BR017019-03	Skidder-Loader Attachment Plate Weldment	1
2	BR001251	Bolt, 3/8-16 x 1.5 inches long	2
3	BR040032	Plate Assembly, Bolt-on	1
4	BR001301	Locknut, 3/8-16	2
5	BR001032	Grommet	4
6	BR005050	High-Pressure Hose, 47 inches long	2
7	BR017029	Thrust Washer	2
8	BR001036	Bushing, Plastic	18
9	BR040101	Bumper	4
10	BR001379	Capscrew, Self-Locking Button Head, 1/4-20 x 5/8"	8
11	BR001306	Locknut, 1/4-20	2
12	BR001405	Flat Washer, 1/4"	2
13	BR040093	Latch Plate	1
14	BR001233	Bolt, 1/4-20 x 1 1/4" long	2
15	BR001210	Bolt (12-Point Socket) Flange Head, 5/8-18 x 2.0 long	6
16	BR001399	Lockwasher	6
17	BR001385	Setscrew, 1/2-13 x 0.5 long	2
18	BR04000C-CM-03	Mount, Assembly (Claw)	1
19	BR001298	Roll Pin	2
20	BR008149	Spring, Torsion	1
21	BR040096	Hub Bearing	2
22	BR040123	Hub	1
23	BR040122	Lock Plate, Hub	1
24	BR040098	Access Cover	1
25	BR001202	Bolt, 5/16-18 x 1" long	2
26	BR001325	Locknut, 5/16-18	2
27	BR001092	Spring	1
28	BR040104	Plunger Pin	1
29	BR001764	Hairpin Clip	1
30	BR001091	Roll Pin	1
31	BR04000C-SP-03	Hinge Pin Assembly, Short	2
31a	BR04000C-03	Claw Assembly	1
31b	BR04000C-HF-03	Housing Frame	1
31c	BR04000C-LA-03	Left Arm Assembly (Link Arm)	1
31d	BR04000C-NF-03	Narrow Finger Assembly	1
31e	BR04000C-WF-03	Wide Finger Assembly	1
32	BR04000C-RA-03	Right Arm Assembly (Link Arm)	1
33	BR04000C-LP-03	Hinge Pin Assembly, Long	1
34	BR001284	Nut, Lock Thread, 7/8-9	3
35	BR001408	Flat Washer, 1 3/8" SAE	2
36	BR001281	Roll Pin, Split, 0.25 x 2.0" long	2
37	BR001406	Flat Washer, 7/8" SAE	3
38	BR040112	Pin, Pivot	1
39	BR001038	Fitting, Swivel	4
40	BR005052	High-Pressure Hose, 17" long	2
41	BR001043	Fitting, Straight	2
42	BR005053	High-Pressure Hose, 19.5" long	1
43	BR004064	Double Acting Cylinder, (1.125 rod dia. x 18 ret. and 27 ext.)	1
44	BR005054	High-Pressure Hose, 15" long	1
45	BR001040	Fitting, Elbow	2

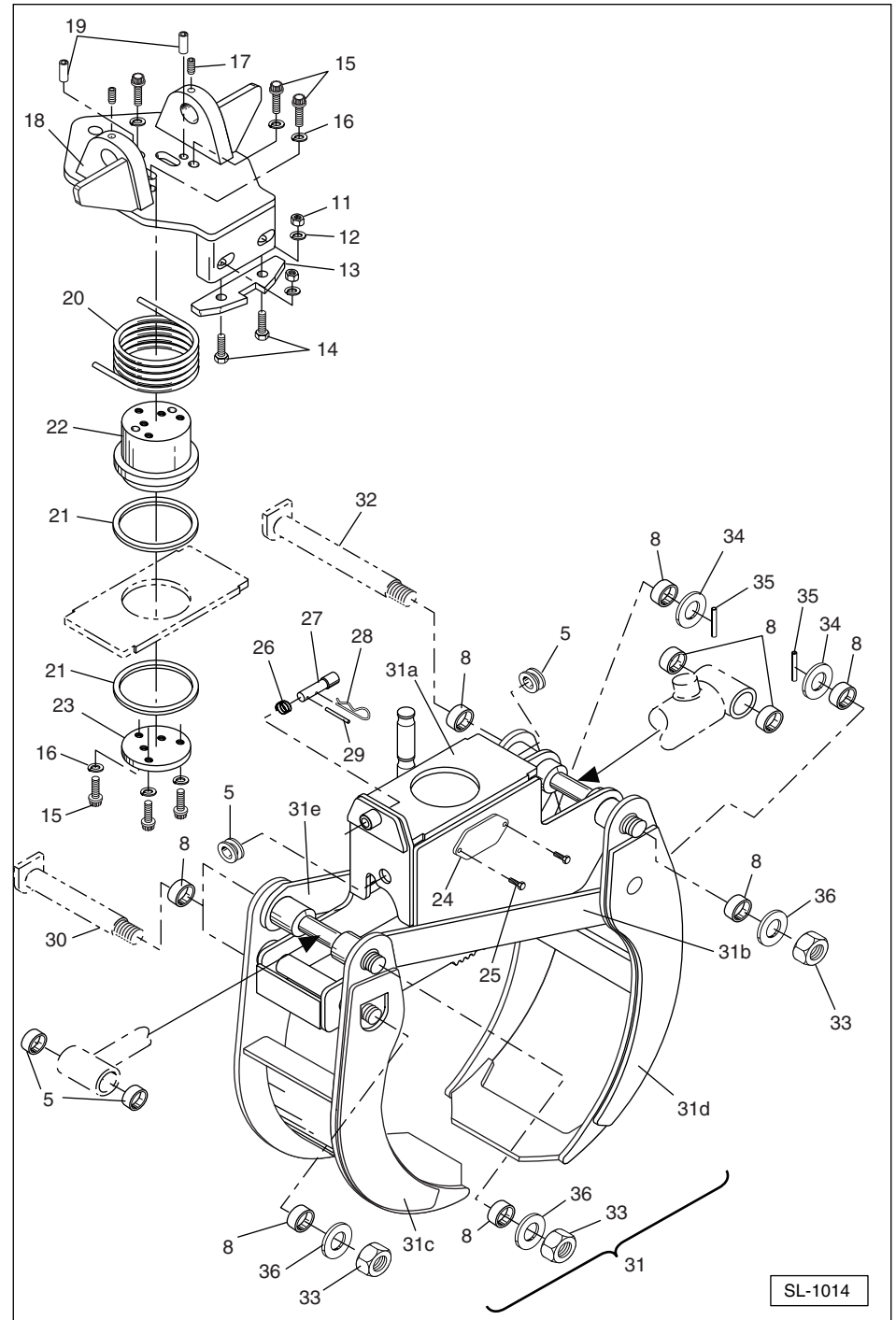
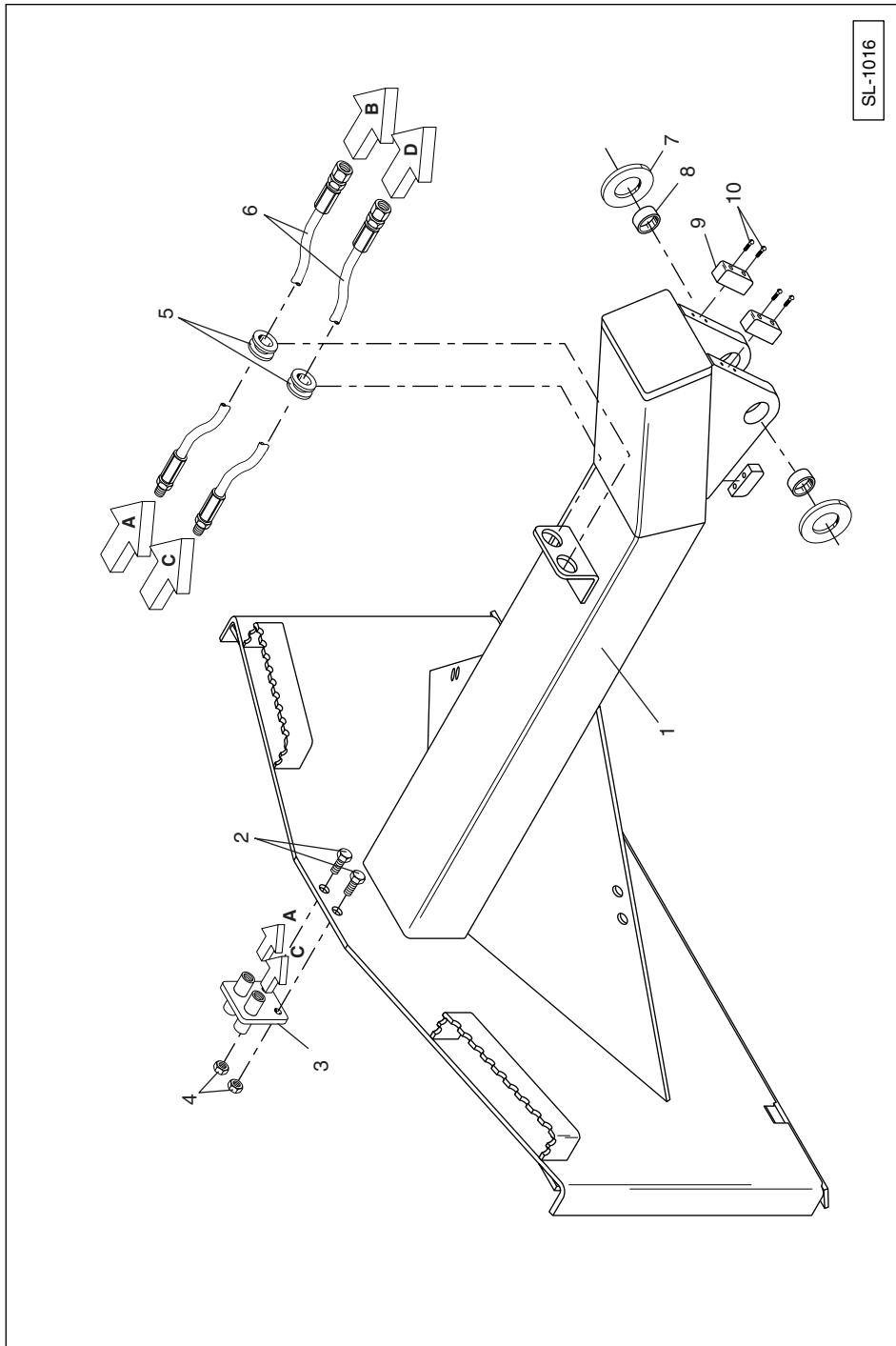

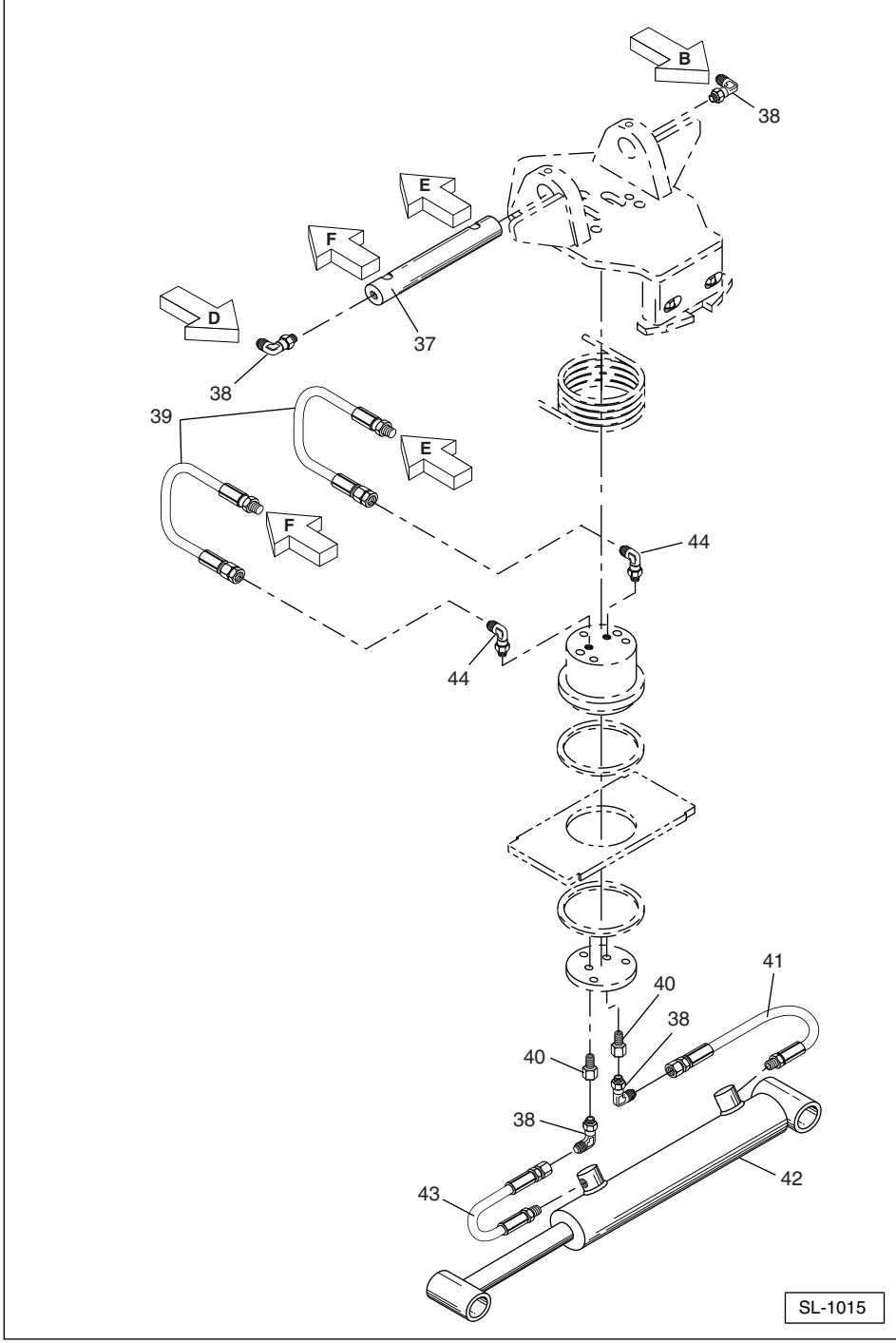

Important Warranty Information

To activate your Iron & Oak Skidder-Loader warranty, please fill out the information in the form below, clip out the form on the dotted line, insert into an envelope, and mail to:

Iron & Oak Commercial Products, Inc.
410 W. Broadway Ave.
Streator, IL 61364-0577

Iron & Oak Skidder-Loader Warranty Information

- Please Print -

Model: SL-03 SERIAL #: _____

OWNER'S NAME: _____

ADDRESS: _____

CITY: _____ STATE: _____ ZIP: _____

Purchased From: _____

Street Address: _____

City: _____ State: _____ Zip: _____

Your Signature: _____ Date: _____

Warranty

For one year from the date of purchase, Iron & Oak Commercial Products Inc. will replace for the original purchaser, or repair free of charge, all parts of the Iron & Oak Skidder-Loader returned to our factory PREPAID and found upon inspection by us to be faulty due to defects in materials or workmanship.

The warranty shall not apply to any unit which has been overloaded or misused or which has been installed, used, or operated contrary to our instructions, or which has been repaired or altered by anyone other than our authorized representative.

We shall not be liable for any contingent liabilities arising out of the improper function of any parts.

We make NO WARRANTY with respect to parts NOT of our manufacture, but we will carry out the terms of the warranties of their respective manufacturers.

For commercial and rental use the warranty period is for 30 days from date of purchase.

If a service representative cannot be found in your area, call Iron & Oak at (815) 672-8596. Have your model and serial number on hand before calling.

Notes



**COMMERCIAL
PRODUCTS™**

**Iron & Oak Commercial Products, Inc.
410 W. Broadway Ave.
Streator, Illinois 61364-0577
Phone: 815-672-8596
Fax: 815-672-9073
E-mail: sales@logsplitters-ironoak.com
Web Site: www.logsplitters-ironoak.com**