

See  
Initial start-up  
instructions on page one



# **BRAVE**

**PRODUCTS, INC.**

## **Brave 22 and 26 Ton Vertical / Horizontal Log Splitters**

**Model VH0622  
Model VH0626**



Photos show Model VH0626

 **Made in U. S. A.**

# **Owner / Operator and Safety Manual**

# Initial Start-Up Instructions

---

- Read all assembly, operating, and safety instructions.
- Complete and return the warranty card to register your log splitter.
- Write the serial number and date-of-purchase in this manual.
- Assemble the log splitter.
- Fill the hydraulic tank with the recommended type and quantity of oil. (See “Start-Up Procedure” section.)
- Fill the engine crankcase with the manufacturer’s recommended type and quantity of oil. (See “Start-Up Procedure” section.)
- Fill the engine fuel tank with fresh, clean, **lead-free** gasoline. (Do not mix oil with gasoline.)
- Bleed the air out of the cylinder before starting the log splitter. (See “Start-Up Procedure” section.)
- Make sure the trailer hitch of the towing vehicle is equipped with a 2 inch ball.

**NOTE:** Brave Products reserves the right to make technical changes for product improvement. This manual may contain illustrations and photographs, for demonstration purposes, which slightly deviate from the actual product design.

**Serial Number** \_\_\_\_\_

**Date-of-Purchase** \_\_\_\_\_

Please enter the serial number and purchase date of your log splitter in the space provided. Keep this manual for future reference.



<b>Introduction</b> .....	2
<b>Safety</b> .....	3
Safety Alert Symbol .....	3
General .....	3
Personal Protection .....	4
Worksite Safety .....	4
Operating Safety .....	5
Log Splitting Safety .....	5
Maintenance and Repair .....	6
Towing .....	6
Refueling .....	7
Preventing Fires .....	7
<b>Assembly Instructions</b> .....	8
Required Tools .....	8
Shipping List .....	8
Unpacking the Crate .....	9
Assembly Procedure .....	10
<b>Start-Up Procedure</b> .....	16
<b>Towing</b> .....	18
<b>Operation</b> .....	19
<b>Inspection and Maintenance</b> .....	27
General Maintenance Check (before operating) .....	27
Engine Service .....	27
Storage .....	27
Hydraulic Oil Change .....	28
<b>Specifications</b> .....	30
Mechanical Specifications .....	30
Hydraulic Specifications .....	30
Replacement Filters .....	30
Hydraulic Oil Specifications (non foaming) .....	30
<b>Troubleshooting</b> .....	31
<b>Decals</b> .....	32
<b>Warranty</b> .....	34
<b>Parts</b> .....	36
<b>Optional Attachments</b> .....	42
Log Cradle .....	42
Log Dislodger .....	42
Safety Flag Kit .....	42
<b>Warranty Card</b> .....	43

# Introduction

---

These professional quality VH0622 and VH0626 Vertical/Horizontal Log Splitters are designed for tough applications in both vertical and horizontal positions. With 22 or 26 tons of splitting force, a 14 second cycle time, and a rugged, horizontal shaft engine, the VH0622 or VH0626 will handle most of your log splitting needs. An attractive, powder-coated finish provides the finest protection available, and Brave's rigid, quality-control and component testing help ensure years of productive, reliable service. Since 1982, the name Brave has stood for quality and reliability when it comes to log splitters and wood processing products.

Brave Products offers the finest log splitter on the market today!

- ✓ Rugged, heavy-duty construction for years of exceptional service.
- ✓ Ergonomic design for use in vertical and horizontal operating positions.
- ✓ Rigid, quality-control during manufacturing ensures greater reliability.
- ✓ Factory testing of all major components and hydraulic tank.
- ✓ Powder-coated finish for the best appearance and weather protection.
- ✓ Year-round manufacturing, parts, and support.

For additional information, contact us at:

Brave Products, Inc.  
410 W. Broadway Ave.  
P.O. Box 577  
Streator, Illinois 61364-0577  
Phone: (800) 350-8739  
Fax: (815) 672-9073  
E-mail: [sales@braveproducts.com](mailto:sales@braveproducts.com)  
Web Site: [www.braveproducts.com](http://www.braveproducts.com)



## Safety Alert Symbol

The safety alert symbol  is used to identify safety information about hazards that can result in personal injury.

A signal word (WARNING or CAUTION) is used with the alert symbol to indicate the likelihood and the potential severity of injury. In addition, a hazard symbol may be used to represent the type of hazard.



**WARNING** indicates a hazard which, if not avoided, **could result in death or serious injury.**



**CAUTION** indicates a hazard which, if not avoided, **might result in minor or moderate injury.**

**IMPORTANT NOTICE** indicates a situation that **could result in damage to the log splitter, cylinder, or engine.**

**The following is a list of safety rules you must follow in order to use your log splitter safely.**

## General



To avoid personal injury or death, carefully read and understand all instructions pertaining to the Brave Products' log splitter.

Do not attempt to operate or maintain our product without fully understanding all our instructions and safety precautions. Do not operate the log splitter unless you read and understand the instructions and warnings in this manual. If any doubt or question arises about the correct or safe method of performing anything found in this or other Brave Products' manuals, contact your Brave Products' dealer or call the Sales and Service representatives at our main headquarters. Proper care is your responsibility.



Accidents can often be avoided by being alert and recognizing potentially hazardous situations. Any individuals operating, maintaining, or repairing products manufactured by Brave Products should have the necessary training, skills, and tools required to perform these functions properly and safely. The safety information in this manual serves as a basic guide in an attempt to prevent injury or death.

Brave Products cannot anticipate every possible circumstance that might involve a potential hazard. The warnings in this manual and on the product itself are, therefore, not all inclusive. If tools, procedures, work methods, or operating techniques that are not specifically mentioned by Brave Products are used, you must satisfy yourself that they are safe for you and for others. Make sure the log splitter will not be damaged or made unsafe by any operation, lubrication, maintenance, or repair procedures that you choose.

# Safety

---







DO NOT proceed if any doubt arises about the correct or safe method of performing anything found in this or other Brave Products' manuals. Seek out expert assistance from a qualified person before continuing.









## CALIFORNIA PROPOSITION 65

Engine exhaust from this product contains chemicals known to the State of California to cause cancer, birth defects, or other reproductive harm.















## Personal Protection

- ✓  To avoid personal injury or death, carefully read and understand all instructions pertaining to the log splitter, including the engine manufacturer's operating and maintenance instruction manual.
- ✓      Always wear protective gear, such as safety goggles, tight-fitting gloves without draw strings or loose cuffs, steel-toed shoes, and a protective hearing device.
- ✓  To prevent injury, make sure all decals are attached to the log splitter and are legible at all times.

## Worksite Safety

- ✓  To avoid tripping, do not leave tools, logs, or other components laying around in the work area.
- ✗  NEVER operate your log splitter on slippery, wet, muddy, or icy surfaces. The location you choose should be flat, dry, and free from any tall grass, brush, or other interferences.
- ✗  NEVER operate the engine in an enclosed area. Exhaust fumes contain carbon monoxide which can be deadly when inhaled. Make sure the area is well ventilated.
- ✗  NEVER attempt to move your log splitter over hilly or uneven terrain without a tow vehicle.
- ✗  NEVER use your log splitter at night.
- ✓  ALWAYS operate your log splitter on dry, solid, level ground.
- ✓  ALWAYS block the wheels to prevent movement of the machine while in operation.

## Operating Safety



- ✓  ALLOW ONLY ONE (1) PERSON TO LOAD AND OPERATE THE LOG SPLITTER.
- ✓  Allow only adults to operate the log splitter - no one under the age of 18.
- ✓  Always keep bystanders, including children and pets, at least twenty-five (25) feet away from the work area. Only the operator should stand near the equipment and only within the safe operating area prescribed in this manual (see the photos on safe and unsafe operating zones in the "Operation" section.)
- ✓  When the ram of the log splitter is in the return mode, keep your hands off the machine — the log splitter is designed to automatically stop when the cylinder is fully retracted.
- ✓  ALWAYS disconnect the spark plug wire when the log splitter is not in operation.
- ✗  Do not allow any person to operate the log splitter until they have read and understood the safe operating instructions contained in this manual.
- ✗  Do not, under any circumstances, alter your log splitter. This equipment was designed and engineered to be used in accordance with the operating instructions. Altering the equipment, or using the equipment in such a way as to circumvent its design capabilities and capacities, could result in serious or fatal injury and WILL VOID THE WARRANTY.
- ✗  Never operate, or allow anyone else to operate, this equipment while under the influence of medication, drugs, or alcohol.
- ✗  Never wear loose clothing or jewelry that may get caught or become entangled in the log splitter.
- ✗  NEVER place hands or feet between log and splitting wedge or between log and ram during the forward or reverse stroke.
- ✗  DO NOT STRADDLE OR REACH ACROSS THE SPLITTING AREA WHEN OPERATING THE LOG SPLITTER.
- ✗  Do not step over your log splitter when the engine is running, because you may trip or accidentally engage the ram.
- ✗  NEVER attempt to load your log splitter while the ram is in motion.
- ✗  Only use your hand to operate the control lever. NEVER use your foot, knee, a rope, or any other extension device.

## Log Splitting Safety









- ✓  Always keep your fingers away from any cracks that open in the log during the splitting operation.

# Safety







---



- ✓  ALWAYS make sure that both ends of the log you are splitting are cut as square as possible. This will prevent the log from sliding out of position while under pressure. Logs should be 24 inches or shorter in length.
- ✗  NEVER try to split two logs on top of each other.
- ✗  Never pile logs to be split in a manner that will cause you to reach across the log splitter.

## Maintenance and Repair









- ✓  Follow all safety rules, because most accidents involving the operation, maintenance, or repair of products occur because the assembler/owner/operator failed to observe basic safety rules or operating instructions.
- ✓  ALWAYS inspect your log splitter before each use. Make sure all nuts, bolts, screws, hydraulic fittings, hose clamps, etc. are securely tightened.
- ✓  ALWAYS check the oil level in the hydraulic oil tank and engine reservoir.
- ✗  NEVER operate your log splitter when it is in need of repair or is in poor mechanical condition.
- ✗  NEVER tamper with the engine to run it at excessive speeds. The maximum engine speed is preset and is within safety limits.
- ✗  NEVER make alterations to your log splitter in any manner. Such alterations may cause the log splitter to become unsafe and **WILL VOID THE WARRANTY.**
- ✗  NEVER attach a rope or extension to the control lever or add width or height to the splitting wedge. Such **ALTERATIONS** may cause the log splitter to become **UNSAFE** and **WILL VOID THE WARRANTY.**
- ✗  ALWAYS clean the unit after each use. If possible, store the unit inside or cover it completely, if stored outside.

## Towing



- ✓  Raise the support leg to the highest position when towing.
- ✓  ALWAYS check before towing to make certain your log splitter is correctly and securely attached to the towing vehicle. Be sure that the ball hitch you are using is the proper size for the hitch coupler on the log splitter (see "Specification" section). Be sure the safety chains are properly hooked to the vehicle leaving enough slack for turning.
- ✓  ALWAYS allow for added length of the log splitter when turning, parking, crossing intersections, and in all driving situations.
- ✓  ALWAYS be careful when backing up. You could jackknife your log splitter if care is not taken.
- ✓  ALWAYS disconnect your log splitter from your towing vehicle before attempting to use it.
- ✗  NEVER exceed 35 m.p.h. when towing your log splitter. Obey all state and local regulations when towing on state and local roads and highways. Adjust your speed for terrain and conditions, as needed. Be extra cautious when towing over rough terrain, especially over a railroad crossing.

- x  NEVER tow your log splitter when there is fuel in the engine's tank.
- x  NEVER allow anyone to sit or ride on your log splitter.
- x  NEVER carry any cargo or wood on your log splitter.

## Refueling

- ✓  ONLY refuel the log splitter outdoors in a clear area void of gas fumes or spilled gasoline.
- ✓  ALWAYS use an approved fuel container to carry gasoline.
- ✓  ALWAYS replace the log splitter gas cap and the fuel container cap securely.
- ✓  If gasoline is spilled, move the machine away from the area of the spill and avoid creating any source of ignition until the spilled gasoline has completely evaporated.
- ✓  Take a class B fire extinguisher with you when operating the log splitter in dry areas as a precautionary measure against possible flying sparks.
- ✓  Always store gasoline in an approved, tightly sealed container. Store the container in a cool, dry place. Do not store the container in a house or near any heating appliance.
- x   Do not smoke or have open flames when refueling the engine. Do not spill fuel. If fuel should spill, quickly wipe up the spill and allow the excess to evaporate before continuing. Make sure gasoline soaked rags are properly disposed of.
- x  DO NOT fill the gas tank while the engine is hot or running. Allow time for the engine to cool down before refueling.

## Preventing Fires

- x  NEVER operate the log splitter near a flame or spark. Oil and gasoline are flammable and can explode.
- x  NEVER smoke while operating or refueling the log splitter. Gasoline, oil, and even gas fumes can explode.

### *Important Notice*

*The log splitter is equipped with an internal combustion engine and should not be used on or near any unimproved forest-covered, brush-covered, or grass-covered land unless the engine's exhaust system is equipped with a spark arrester meeting local or state laws (if any). If a spark arrester is used, it should be maintained in effective working order by the owner and/or operator.*



## Unpacking the Crate

1. Cut the metal banding and remove the top, sides, ends, and protective plastic covering of the packing crate. Do not unband or remove the base unit or the rail unit from the bottom pallet at this time.

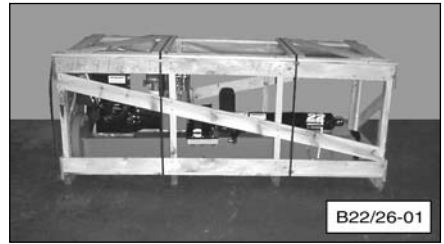

2. Without cutting the banding straps, carefully check the larger components on the crate for shipping damage. If the parts are damaged call Brave Products at (800) 350-8739.

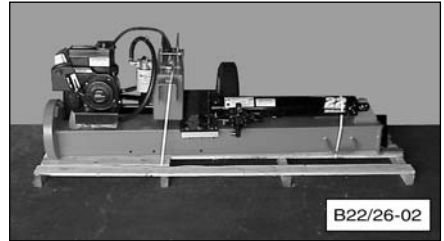

3. Open the cardboard box and make sure all the smaller parts have been shipped. The chart in the "Shipping List" section provides a complete list of all the parts shipped with your log splitter. If any parts are missing, call Brave Products at (800) 350-8739.

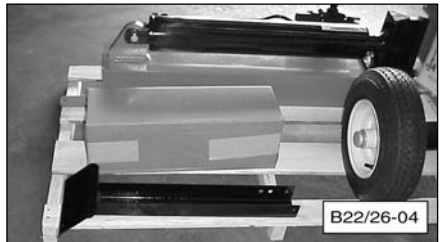
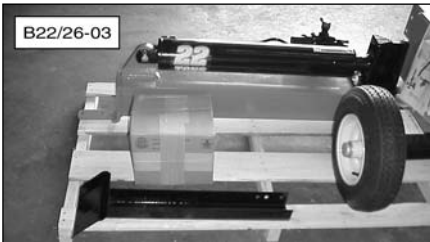

**NOTE:** The contents of the cardboard box includes the hitch assembly, valve handle, two safety chains, and one bag of hardware, as shown. The contents will also include the fenders and mounting brackets for model VH0626 only.



Model VH0622

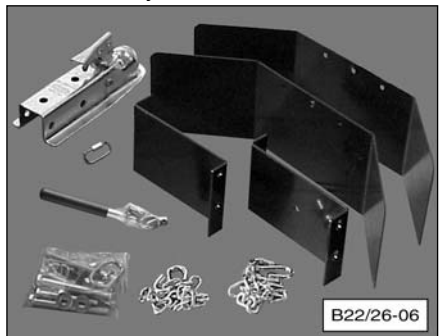

Model VH0626

# Assembly Instructions

## Assembly Procedure

### ⚠ CAUTION



Some components are very heavy and can be damaged if mishandled. To help prevent personal injury, it is strongly recommended that two (2) people work together to uncrate and assemble the log splitter.

1. Remove and read all instructions and safety recommendations before assembling or operating this log splitter.

### ⚠ CAUTION

The rail assembly is bolted to the pallet with a lag screw. The rail is top heavy and can tip over when it is unbolted, which could cause personal injury. Make sure the pallet is on a flat, level surface before removing the bolt.

2. Cut the bands holding the base unit and rail assembly onto the pallet. Before removing the base unit from the pallet, install the front leg assembly. Align the top rear hole in front leg with the rear top hole in the base unit and install a 1/2-13 x 4-1/2 inch long hex head bolt through the holes. Install and tighten the locknut.

**NOTE:** To prevent the front leg from binding, do not overtighten the locknut.

3. Place the front leg in the 45 degree down position and install the hitch pin through the lower front hole of the base unit and front leg.
4. Install the hair pin clip through the hitch pin.



# Assembly Instructions

5. Lift the front leg and carefully roll the base unit off the pallet.
6. Carefully stand the rail assembly in an upright, vertical position.

## **⚠ WARNING**

**Make sure the rail assembly is standing on a flat, level area. If necessary, have a helper steady the rail to prevent it from tipping over. The rail assembly weighs approximately 270 pounds and will cause bodily injury if it falls on someone.**

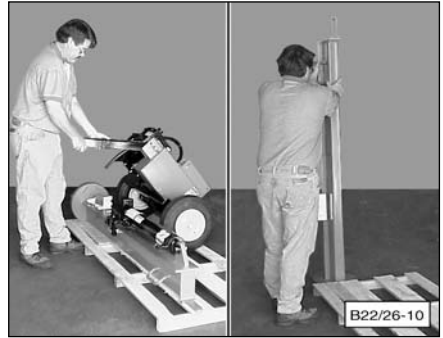

7. Carefully align the base assembly, using the front leg, with the rail assembly.



**Have someone hold the rail assembly to prevent it from falling during this part of the assembly.**

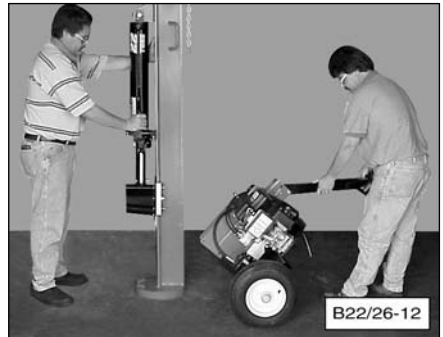

8. Center the rail between the hinge plates on the base assembly, as shown. Insert a 1/2-13 x 4-1/2 inch long hex head bolt through rear top hole of the hinge plates and rail. Install and tighten a 1/2-13 locknut.

**NOTE:** To prevent the rail from binding, do not overtighten the locknut. This connection serves as the pivot point for the log splitter from the vertical to horizontal position.



# Assembly Instructions

9. Put one foot on the base plate of the front leg to prevent the log splitter from tipping up and lower the rail to a horizontal position.

**NOTE:** Block the wheels to prevent the base unit from moving.

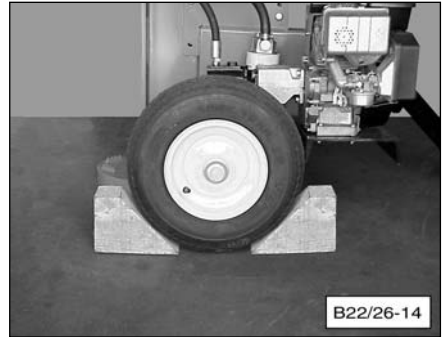

10. Insert the hitch pin through the top, front hole of the hinge plates, through the rail and secure it with a hair pin clip on the opposite side.



11. Link the ends of safety chains together with the safety quick-link and tighten the link's locknut securely with a wrench.



12. Place the hitch over the attachment tube, aligning the bolt holes, and insert the rear 1/2 x 3 inch bolt (A). Install and tighten the locknut.

Insert the end of quick link into front tube of the rail assembly and insert a 1/2 x 3 inch bolt (B) through link and hitch. Install and tighten the locknut.

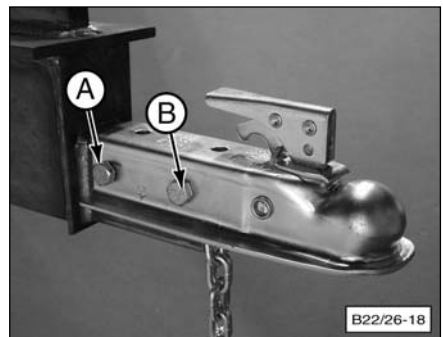

# Assembly Instructions

13. Insert the chain link into the valve body as shown, with the pins facing upward.

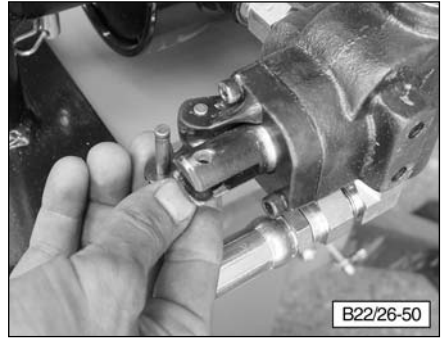

14. Position the control lever as shown and install it onto the chain link pin. Place the chain link side plate on top of the two pins.

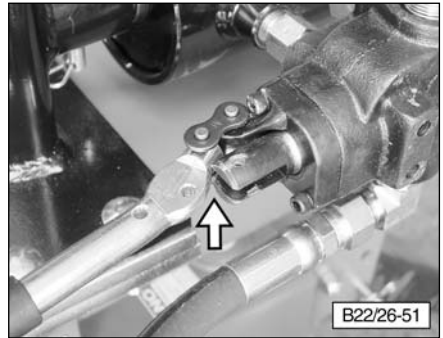

15. Secure the side plate by using a pair of pliers to slide the retaining clip in place onto the two pins.

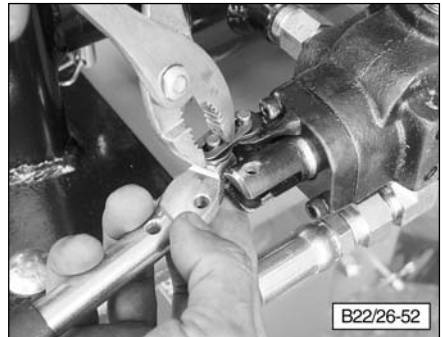

16. Attach the control lever to the valve spool using a 1/4" x 1" long clevis pin. Secure the clevis pin with a cotter pin (bend the ends of the cotter pin to hold it in place).

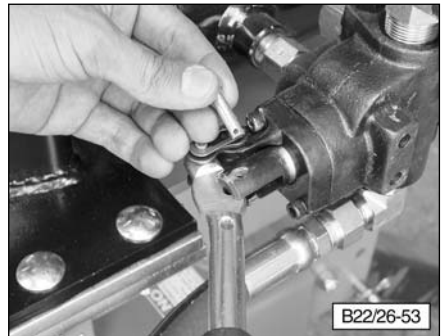

# Assembly Instructions

17. Attach high-pressure hose (A) to the bottom valve fitting.

**NOTE:** The high-pressure hose is self-sealing and does not require any type of sealing material. Tighten the fitting with the 10 inch crescent wrench.

18. Attach the end of low-pressure return hose (B) to the fitting on top of the valve. Position and tighten the hose clamp approximately  $\frac{3}{8}$  inch from the end of the hose.

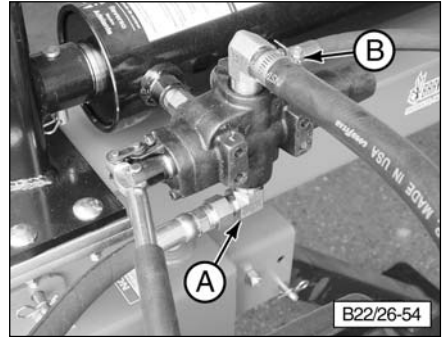

**NOTE:** Steps 19 and 20 apply to installation of fenders on model VH0626 only.

19. Install the left and right-hand fender brackets using two  $\frac{5}{16}$ -18 x  $\frac{3}{4}$  inch long hex head bolts and locknuts for each bracket. Install the bracket with the slotted holes against the base unit (round holes up).

**NOTE:** The right-hand side of the log splitter is the right side when viewed from the hitch end.



20. Bolt the fenders onto the fender brackets using two  $\frac{5}{16}$ -18 x  $\frac{3}{4}$  inch long hex head bolts and locknuts. The fenders are interchangeable (left or right). Position the fender with the bolts in the middle and front holes. This should place the fender over the tire with equal spacing in the front and back.



# Assembly Instructions

---

21. The log splitter is now completely assembled. **Follow the “Start-Up Procedure”, in the following section, which adds oil to the engine and hydraulic tank before trying to start the engine.**



Model VH0622



Model VH0626

# Start-Up Procedure

---

## Important Notice

*Follow all the instructions listed below before starting or operating your log splitter. Failure to do so may result in engine and hydraulic pump damage. Also read the Briggs & Stratton Operating & Maintenance Instructions. If you do not have this manual, contact Briggs & Stratton at 800-233-3723 to obtain another one or download a copy from their web site at [www.briggsandstratton.com](http://www.briggsandstratton.com).*

If this log splitter is purchased without an engine, the customer assumes all liabilities that might arise from an engine that is incompatible with the design of the log splitter. Also, any unauthorized changes or modifications to the log splitter will void all warranties.

1. Fill the hydraulic tank with 3.8 gallons of SAE 10W tractor hydraulic oil or automatic transmission fluid such as Dextron III. The tank is full when the oil level is approximately one inch from the top of the tank. Do not tighten the fill cap at this time.

**NOTE:** The total hydraulic system oil capacity for this unit is 5.4 gallons.

2. Fill the engine's crank case with the engine manufacturer's recommended oil.
3. Lubricate the surface of slide rail with grease. This will help to prevent wear between the slide plates and the slide rail.
4. Remove the spark plug wire from the engine. This prevents the engine from starting until the hydraulic pump and cylinder are completely filled with oil. Make sure the spark plug wire is held away from the spark plug with string or other nonconductive material.
5. Push the valve control handle, with one hand, to the forward (extend) position (towards the front of the cylinder). Pull the engine starter cord, with the other hand, (approximately 15 times) until the cylinder piston moves forward. (Keep everything away from the pusher plate and slide wedge during this step.)

**NOTE:** Extending the cylinder piston draws the hydraulic fluid through the system and expels any trapped air in the system.

6. Check the fluid level in the hydraulic tank and add oil as needed.

### **WARNING**



**Be careful not to spill fuel when filling the engine. If fuel should spill, quickly wipe off and allow the excess fuel to evaporate before continuing. Fuel and fuel vapors are highly flammable and can cause personal injury or even death when ignited.**

## *Important Notice*

*If your log splitter is equipped with a factory installed engine, do not mix oil with the gasoline. Using mixed oil/gasoline in a four cycle engine can cause engine damage.*

7. Fill the engine's fuel tank with fresh, clean, lead-free automotive gasoline.
8. Attach the spark plug wire and start the engine per the manufacturer's instructions.
9. With the engine running, push the valve control handle to the retract position and retract the cylinder piston. The cylinder valve will automatically stop the cylinder from retracting when it reaches the end of its stroke. Cycle the log splitter several times.
10. Again, check the fluid level in the hydraulic tank and add oil as needed. Replace and tighten the fill cap.
11. Your log splitter is now ready to use.

# Towing

## ⚠ WARNING

### Maximum Speed Limit — 35 mph

Your log splitter is built on a solid, unsuspended axle. To prevent damage or possible loss of vehicle control, use extreme caution when towing and do not exceed a vehicle speed of 35 mph, especially when driving on a bumpy road.

1. Position the hitch on log splitter over or onto the tow vehicle's tow ball. Pull the latch assembly on the hitch up and into the open position. In some cases, the hitch may not totally engage with the ball without raising the front leg of the log splitter.

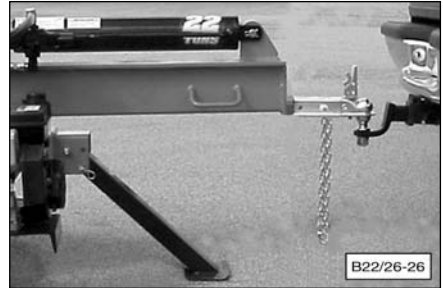

2. Release the latch assembly on the hitch and lock the hitch onto the ball. Place a customer supplied lock or lock pin into the latch assembly of the hitch.



3. Raise the front leg to the towing position by removing the hair pin clip and the hitch pin. If not already secure, make sure the hitch on the log splitter is properly and securely attached to the ball. Raise the front leg, align the top front hole, and install the hitch pin and hair pin clip.



4. Attach the towing safety chains to the tow vehicle.

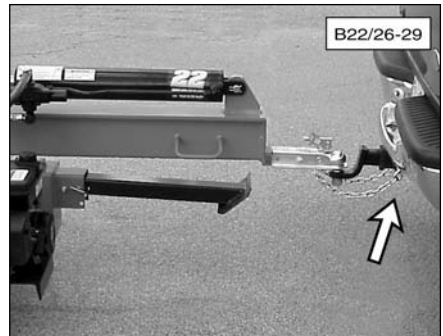

## ⚠ WARNING

**Making sure the log splitter is securely attached to the vehicle is the responsibility of the owner/operator. Failure to securely attach the log splitter can cause loss of control of the vehicle or the log splitter being separated from the towing vehicle, resulting in serious injury or death.**

## ⚠ WARNING



Do not attempt to operate the log splitter without fully understanding all our instructions, safety precautions, and/or warnings. If any doubt or question arises about the correct or safe method of performing anything found in this or other Brave Products' manuals, contact your Brave Products' dealer or call the Sales and Service representatives at our main headquarters. Proper care is your responsibility.



Before loading and operating the log splitter, put on the proper protective gear, such as safety goggles, face shield, hearing protection (ear muffs or ear plugs), tight-fitting gloves (without drawstrings or loose cuffs), and steel-toed shoes.

When operating the log splitter, make sure you are standing in the **safe operating zone**, as shown in these pictures. You must stay in the **safe operating zone** at all times when the splitting wedge is in motion (whether extending or retracting). Never place any part of your body into a position that would cause an unsafe operating condition.

1. Set your log splitter on flat, dry ground. Make sure you read all recommendations from the "Safety" section, before using the log splitter.
2. Make sure both ends of the log you are splitting are cut as square as possible. This will prevent the log from sliding out of position while under pressure. All logs should be 24 inches long or shorter.

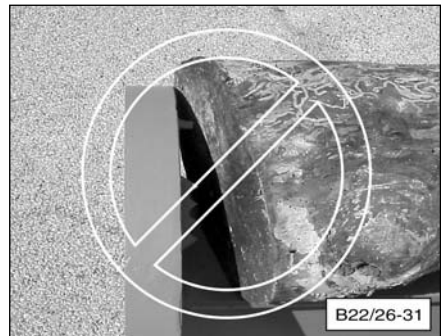

# Operation

## ⚠ CAUTION

Never attempt to split wood across the grain. The log splitter was not designed for cross-grain splitting. Doing so will damage the log splitter and may cause personal injury.

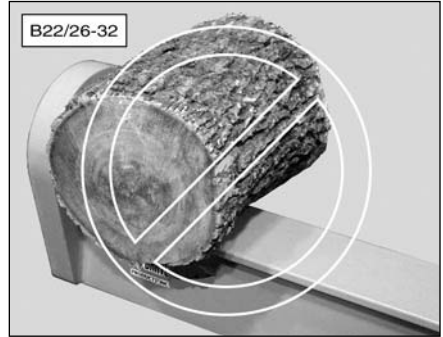

3. Start the engine using the instructions from the engine manual. If the log splitter has not been running (cold engine), warm up the engine and hydraulic system by running the engine at half throttle for 3 to 4 minutes, then advance the engine throttle control to maximum speed.

## Operation – Horizontal Position

4. Use the following photos for the correct and incorrect methods of splitting logs. Never split a log using an incorrect or unsafe method.
  - a. Place the log on the log splitter. Grasp the log on the sides near the middle of the block. Center the log, side-to-side, on the rail of the log splitter, making sure that the sawed end is against the large plate (base plate) at the opposite end from the hydraulic control valve control lever.



## ⚠ WARNING



Do not place your hands on the ends of the log when loading the log splitter. This is a very UNSAFE method and could result in injury to your hands.

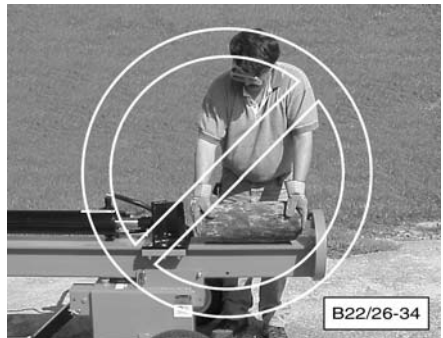

- b. Only using your hand, push the control lever forward (towards the log). If the log moves before it is contacted by the splitting wedge, release the control lever and then reposition the log. Operate the log splitter only when standing in the safe operating area, as shown in the picture.

## **⚠ WARNING**



Make sure you stand clear from the engine's exhaust. Hot exhaust is intense and can cause serious injury.



## **⚠ CAUTION**



If you find you must hold the log until the wedge touches it and holds it in place, be very careful not to put your hand between the log and the end plate or the log and the wedge. If you must, hold the log on top and in the middle. Remove your hand immediately when the splitting wedge engages the log. Never use your hip or any extension device to operate the valve control handle.



## **⚠ WARNING**



Do not operate the log splitter by reaching across the rail. This is a very UNSAFE method which could cause personal injury or even death.

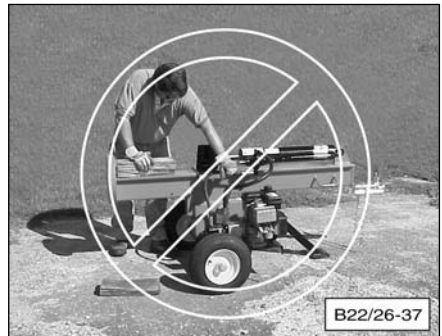

# Operation

## ⚠ WARNING



Do not reach or step across the rail while the log splitter is running. This is a very **UNSAFE** method which could cause personal injury or even death.

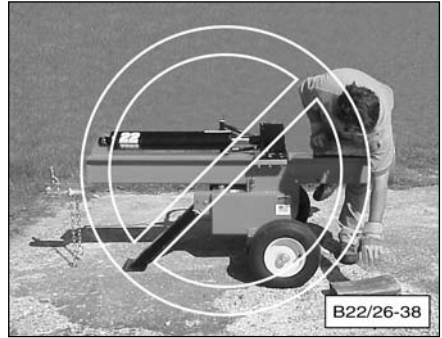

5. Using only your hand, push the control lever forward, toward the base plate. If the log moves before it is contacted by the splitting wedge, release the control lever to STOP the wedge, then reposition the log and continue splitting. Hold the control lever to extend the cylinder until the log is split or the cylinder rods stops at its maximum travel position. **DO NOT** reach forward and attempt to catch the split wood. Let it fall to the ground.

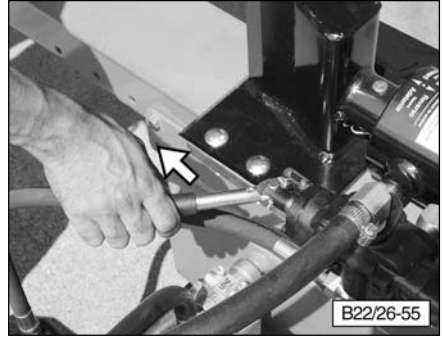

6. Pull back on the control lever to the full retract position. Stop the wedge if the log sticks (see caution below). It is not necessary to hold the control lever.

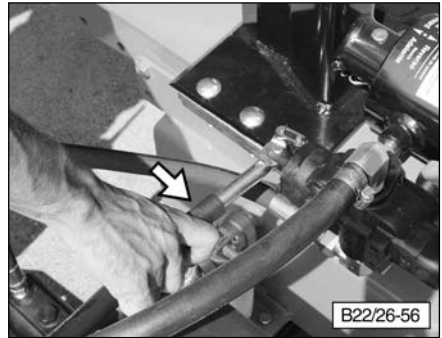

## ⚠ CAUTION



Depending on the type of wood being split, a log may not always break into two pieces and fall to the ground. If a log sticks to the wedge, place the valve handle in the neutral position (stop the wedge from retracting) and carefully remove the log from the wedge. Allowing the log to remain attached to the wedge when it is fully retracted could lead to possible injury and/or damage to the log splitter.

7. When the cylinder is fully retracted, the control valve will automatically shift to the Neutral position.

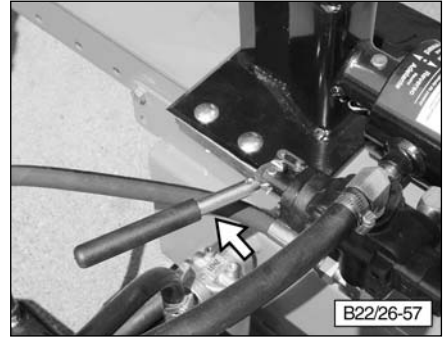

## Operation – Vertical Position

1. Use the following photos for the correct and incorrect methods of splitting logs. Never split a log using an incorrect or unsafe method.

**NOTE:** To operate the log splitter in a vertical position, block the wheels, and remove the hair pin clip and hitch pin. Never reposition the log splitter from horizontal to vertical positions when the engine is running. Place your foot on the bottom plate of the front leg and carefully tilt the rail to the vertical position. Insert the hitch pin into the bottom hole of the base unit and through the slide rail. Secure the hitch pin with the hair pin clip. After the log splitter is secured in a vertical position, start the engine using the procedure in Step 3.

- a. Move the log under the splitting wedge keeping your hands on the sides of the log near the middle of the block. Center the log making sure that the sawed end is sitting on the large plate (base plate).



# Operation

## ⚠ WARNING



Do not place your hands on top of the log when loading the log splitter. This is a very UNSAFE method and could result in injury to your hands.

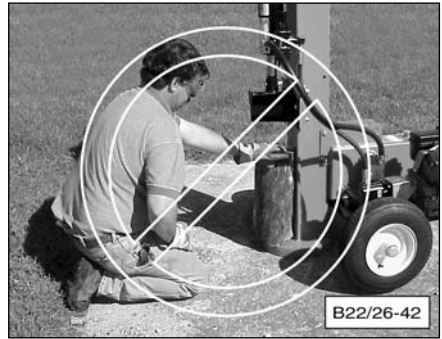

## ⚠ WARNING



Do not put your hand on top of the log when the log splitter is running.

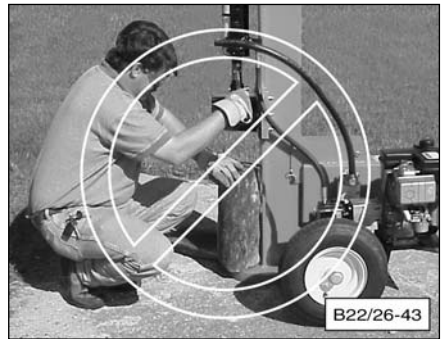

## ⚠ CAUTION



If you find you must hold the log until the wedge touches it and holds it in place, be very careful not to put your hand on top of the log. If you must, hold the log in the middle of the block. Remove your hand immediately when the wedge engages the log. Never use your hip or any extension device to operate the valve control handle.



- b. Operate the log splitter only when standing in the **safe operating area**, as shown in the picture.

## **⚠ WARNING**



**Make sure you stand clear from the engine's exhaust. Hot exhaust is intense and can cause serious injury.**



B22/26-45

2. Using only your hand, push **DOWN** on the control lever, toward the baseplate. If the log moves before it is contacted by the splitting wedge, release the control lever to stop the wedge, then reposition the log and continue splitting. Hold the lever to extend the wedge until the log is split or the cylinder rod stops at its maximum travel position. **STOP** the forward movement if you feel an unsafe condition is occurring. **DO NOT** reach forward to grab the split wood.

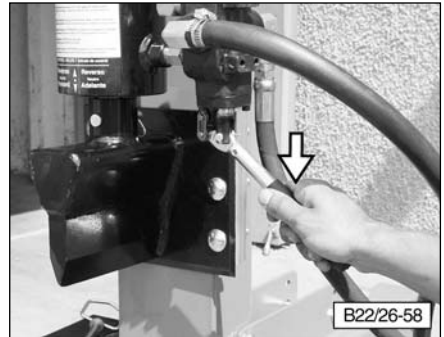

B22/26-58

3. Once the wedge reaches its full forward downward travel, push **UP** on the control lever to retract the cylinder.

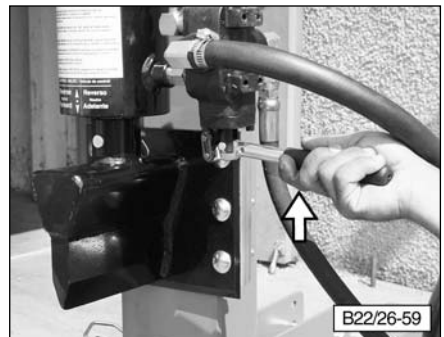

B22/26-59

# Operation

---

4. It is not necessary to hold the control lever. The cylinder rod will automatically retract, and when its fully retracted, the handle returns to Neutral.

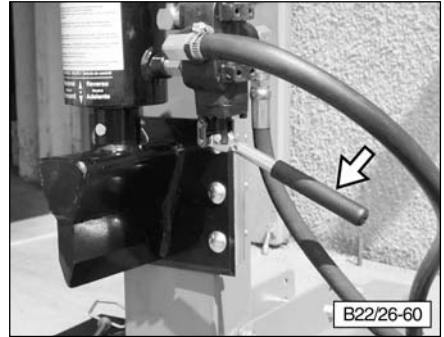

## **⚠ CAUTION**



Depending on the type of wood being split, a log may not always break into two pieces and fall to the ground. If a log sticks to the wedge, place the valve handle in the neutral position (stop the wedge from retracting) and carefully remove the log from the wedge. Allowing the log to remain attached to the wedge when it is fully retracted could lead to possible injury and/or damage to the log splitter.

---

## General Maintenance Check (before operating)

The hydraulic system (hoses, cylinder, and pump) should be carefully inspected before each use. Also, inspect the mechanical parts at the same time. Make sure all clamps, nuts, bolts, fittings, etc. are properly installed and tightened.

### **⚠ WARNING**



**Do not check for leaks with your hand. Leaks can be located by passing a piece of cardboard or wood around the suspected leak and looking for discoloration. High-pressure fluid escaping from a very small hole can be almost invisible. Escaping fluid under pressure can have sufficient force to penetrate skin, causing serious injury or even death. If fluid is injected into your skin, it must be treated immediately by a doctor familiar with this type of injury.**

---

Always replace frayed, kinked, or cracked hoses and/or other damaged hydraulic components with Brave Products authorized parts and components specified in the “Parts” section of this manual. Replacement parts from secondary suppliers (not original Brave replacement parts) can lead to product damage and/or personal injury, and will void the warranty.

### **⚠ CAUTION**



**Do not remove the cap from the hydraulic tank or reservoir while the log splitter is running. Hot oil, under pressure, could be expelled, resulting in serious injury.**

---

Should it become necessary to loosen or remove any hydraulic fitting or hose, be sure to relieve all hydraulic pressure by shutting off the engine, removing the spark plug wire, and moving the valve control handle back and forth several times until no cylinder movement is visible.

## Engine Service

Refer to the engine manufacturers' manual for engine maintenance and repair.

## Storage

Refer to the engine manufacturers' manual for engine storage. No special procedures are required for the hydraulic system to store the log splitter.

# Inspection and Maintenance

## Hydraulic Oil Change

Brave Products recommends an oil and filter change every 100 hours of operation. Refer to the “Specifications” section in this manual for the type and quantity of oil.

### *Important Notice*

*Never run the log splitter unless the hydraulic oil tank is full.*

#### 1. Drain the head end of the cylinder.

- a. Remove the spark plug wire and spark plug to help reduce the back pressure on the engine and to prevent it from starting.
- b. Disconnect return hose (1) from the oil filter housing and place it in a waste oil container. (Please properly dispose of the waste oil per local regulations.)
- c. Extend the cylinder by holding the valve handle forward and pulling on the engine’s pull start cord until oil from the return line stops flowing. This step drains the head end of the cylinder.

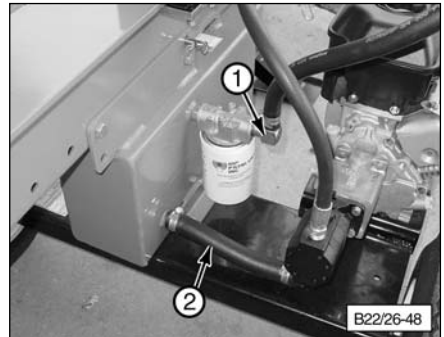

#### 2. Drain the hydraulic tank.

- a. Place a waste oil container under inlet hose (2).
- b. Remove the inlet hose from the pump.
- c. Slightly raise the front of the log splitter to completely drain the tank.

#### 3. Remove and replace the oil filter.

- a. Remove the existing oil filter and properly dispose of it.
- b. Apply a thin coat of oil to the rubber seal of the new oil filter.
- c. Screw the filter onto the filter head. Once the filter makes contact with the filter head, turn it an additional 3/4 turn. Hand-tighten only.



## Important Notice

*DO NOT mix tractor hydraulic oil with transmission fluid. Use one or the other.*

4. Refill the hydraulic tank.
  - a. Reconnect inlet hose (2) to the pump.
  - b. Remove the hydraulic tank fill cap and fill the tank with the recommended type and quantity of oil. Replace the cap.

5. Drain and refill the piston end of the cylinder.

**NOTE:** Hose (1) should still be in the waste oil container.

- a. Hold the valve handle in the retract position and pull the engine pull start cord until the rod is fully retracted. This step removes the old oil from the piston end of the cylinder.
  - b. Reconnect return hose (1) to the oil filter.
  - c. Extend the cylinder by holding the valve handle forward and pulling on the engine's pull start cord until the cylinder is completely extended. This step refills the piston end of the cylinder.
6. Start the engine and cycle the cylinder.
    - a. Replace the spark plug and spark plug wire.
    - b. Start the engine and cycle the cylinder several times.
    - c. Retract the cylinder and shut off the engine.
    - d. Recheck the hydraulic tank to make sure oil is filled within one inch from the top of the tank.

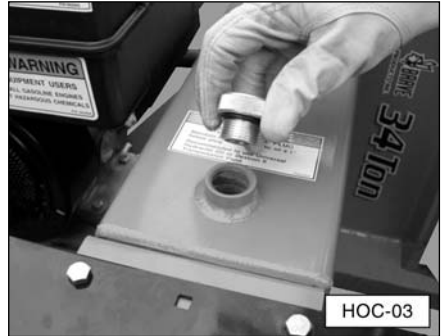

# Specifications

---

## Mechanical Specifications

Slide Rail	3 x 6 inch reinforced, heavy-duty formed channel
Wedge	High carbon steel, compound angle
Force/Tonnage	22 ton <sup>1</sup> or 26 ton <sup>2</sup>
Cylinder Stroke	24 inches
Log Opening	25 inch maximum
Cycle Time	14 seconds (approx.)
Operating Positions	Vertical/Horizontal
Wheels & Tires	High-Speed, 4.80 x 8"
Safety Chains	Standard
2" Hitch Coupler	Standard
Engine	6.5 HP Briggs & Stratton (standard) <sup>1</sup> , or .5 HP Honda GC or 5.5 Honda GX (optional) <sup>1</sup> .8 HP Briggs & Stratton Powerbuilt horizontal shaft (standard) <sup>2</sup> , or .9 HP Honda GX or 9 HP Honda GX Electric Start (optional) <sup>2</sup>

## Hydraulic Specifications

Cylinder (Clevis-Type)	4 x 24 inch, with 1.75 inch rod <sup>1</sup> or 4-1/2 x 24 inch, with 2 inch rod <sup>2</sup>
Hydraulic Tank Capacity	3.8 gallons
Hydraulic System Capacity (including cylinder, tank, hoses, and filter)	5.4 gallons
Hydraulic Oil Filter	Spin-on, 25 micron filter
Safety Release Control Valve	Detent, auto return
Gear Pump	2-stage, 11 GPM <sup>1</sup> or 16 GPM <sup>2</sup>
Unit Weight	540 lbs. <sup>1</sup> or 560 lbs. <sup>2</sup>
Shipping Weight	590 lbs. <sup>1</sup> or 610 lbs. <sup>2</sup>

<sup>1</sup> Model VH0622 only.

<sup>2</sup> Model VH0626 only.

## Replacement Filters

Replacement Filters	NAPA 1553
	FRAM PF1654
	WIX 51552

## Hydraulic Oil Specifications (non foaming)

Tractor Hydraulic Oil	
For extremely cold weather conditions	SAE 10W
For extremely warm weather conditions	SAE 30W
Transmission Fluid	Dextron III

### *Important Notice*

*DO NOT mix tractor hydraulic oil with transmission fluid. Use one or the other.*

The following section details procedures for checking your log splitter, should you encounter a malfunction. Brave Products, Inc. recommends that you do not attempt to make repairs to the log splitter. In the long run, it is better to take your log splitter to a servicing lawn and garden dealer for repairs.

**Problem:** When the control handle is pushed forward (extend), the splitting wedge does not move.

1. Check the hydraulic tank to make sure the oil level is one inch from the top of the tank.
2. Remove the pump from the engine flange. Check the coupler, making sure the drive keys are in place and there is no damage to the blue urethane spider.
3. Disconnect the splitting wedge from the cylinder. Grasp the hydraulic cylinder shaft and try to pull it out. If the rod comes out easily, you will need to rebuild or replace the cylinder.
4. Once you have determined that the engine-to-pump coupler is intact and the cylinder is in good condition, you will need to replace the pump.

**Problem:** The engine stalls when the splitting wedge engages the wood.

1. The engine may not be properly adjusted. Take the engine to a service center for repair and/or adjustment.
2. If all engine settings are correct, replace the pump.

**Problem:** The splitting wedge moves slowly, but will split wood.

1. Check the oil level in the hydraulic tank and fill if necessary.
2. Check the high-pressure hose, fittings, and valve openings for dirt and debris that may have obstructed the openings.
3. If the ram speed is still slow, replace the pump.

**Problem:** The ram will not automatically retract.

1. Check the slide rail or wedge assembly for damage.
2. Push the valve handle to the retract position. If the handle will not stay in this position, replace the valve assembly.

**Problem:** Oil squirts from the fill plug during operation.

1. The oil tank may be over-filled. Drain oil to 1 inch below the top of the tank.
2. The log splitter is not level. Make sure the log splitter is on level ground.

# Decals



Make sure all decals are attached to the log splitter and/or engine and are legible at all times. If you are missing a decal or one is not legible, call Brave Products at 800-350-8739 for a replacement.

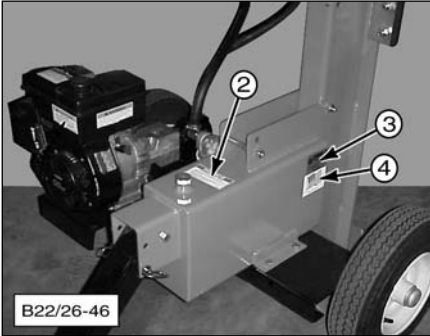

B22/26-46



B22/26-47

(1)

## Operator Safety

Seguridad del operario

---

**CAUTION / PRECAUCIÓN**

- Read Owner/Operator manual completely.**  
*Lea todo el manual del propietario/operario.*
- Operate log splitter on flat, dry ground.**  
*La cortadora de troncos debe estar sobre suelo firme y seco.*
- Lock rail into Vertical or Horizontal position before using.**  
*(Some Iron & Oak models operate only in Horizontal position.)  
Trabe el riel en posición Vertical u Horizontal antes de usarlo.  
(Algunos modelos Iron & Oak solo usan la posición Horizontal.)*
- NO ONE under age 18 is allowed to operate log splitter.**  
*NINGUNO menor de 18 años está autorizado a utilizar la cortadora de troncos.*
- Keep bystanders, children, and helpers at least 25 ft. away.**  
*No permita que observadores, niños y ayudantes se acerquen más de 25 pies-7,6m.*
- Wear safety glasses, tight fitting work gloves, and safety shoes.**  
*Use lentes de seguridad, guantes de trabajo ajustados y zapatos de seguridad.*

---

**WARNING / ADVERTENCIA**

- Keep hands and all body parts away from splitting wedge, base plate, partially split wood, and moving parts.**  
*Aleje las manos y el cuerpo de la cuña cortadora, la base de apoyo, la madera cortada parcialmente y las piezas móviles.*
- Hold logs by the sides, not the ends.**  
*Tome los troncos por los lados, no por los extremos.*
- Only one person is permitted to stabilize logs and operate the controls.**  
*Sólo una persona debe estabilizar los troncos y operar los controles.*
- Do not check for oil leaks with your hand. Use a cloth.**  
*High pressure hydraulic fluid can penetrate your skin, causing blood poisoning.*  
*No utilice la mano para ver si hay pérdidas de aceite. Use un paño.  
El fluido hidráulico con alta presión puede penetrar la piel y provocar envenenamiento.*
- Never operate log splitter under the influence of alcohol or drugs.**  
*Nunca opere la cortadora de troncos si ha bebido o tomado drogas.*

---

**OPERATING INSTRUCTIONS / INSTRUCCIONES OPERATIVAS**

- 1. Read Owner/Operator manual for complete instructions.**  
*Lea el manual del propietario/operario para ver todas las instrucciones.*
- 2. Start engine using instructions from engine manual.**  
**Advance throttle control to maximum speed.**  
*Ponga en marcha la máquina según el manual del motor. Lleve el regulador a la velocidad máxima.*
- 3. Grab log by sides and place onto rail, against base plate.**  
*Tome el tronco por los lados y colóquelo sobre el riel, contra la base de apoyo.*
- 4. If necessary, stabilize log by holding the side, never the end.**  
*Si es necesario, estabilice el tronco tomándolo de un costado, no del extremo.*
- 5. Move control handle to FORWARD position to extend splitting wedge.**  
*Coloque la manivela de control en ADELANTE para alargar la cuña cortadora.*
- 6. Release handle to STOP splitting wedge.**  
*Libere la manivela para DETENER la cuña.*
- 7. Move control handle to REVERSE position to retract splitting wedge.**  
*Coloque la manivela de control en REVERSO para retraer la cuña cortadora.*

---

**CONTROL VALVE / Válvula de control**

**Reverse**

Neutral

**Forward**

**Reverso**

Neutro

**Adelante**

(2)



(3)



(4)

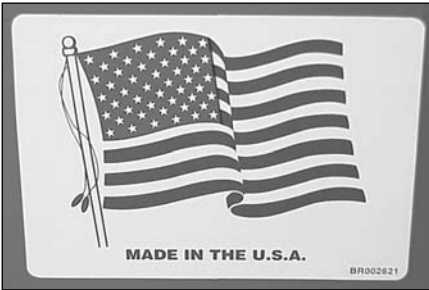

(5)



(8)

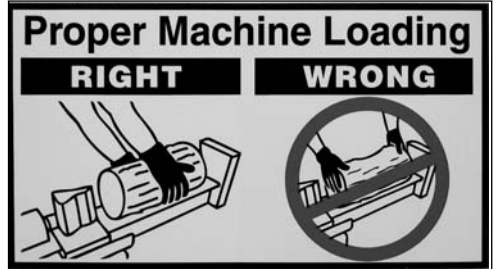

Item	Part No.	Description	Qty.
1	BR002302	Decal, Operator Safety	1
2	BR002652	Decal, Notice	1
3	BR002521	Decal, Serial Number	1
4	BR002621	Decal, Flag	1
5 (NS)	BR002653	Decal, Maximum Speed	1
6 (NS)	BR002622	Decal, 22 Ton Logo	2 <sup>1</sup>
7 (NS)	BR002624	Decal, 26 Ton Logo	2 <sup>2</sup>
8 (NS)	BR002559	Decal, Proper Machine Loading	1

NS = Not Shown

<sup>1</sup> VH0622.

<sup>2</sup> VH0626.

# Warranty

---

For one year from the date of purchase, Brave Products Inc. will replace for the original purchaser, or repair free of charge, all parts of the Brave Products' Hydraulic Log Splitter, returned to our factory PREPAID and found upon inspection by us to be faulty, due to defects in materials or workmanship.

The warranty shall not apply to any unit which has been overloaded or misused or which has been installed, used, or operated contrary to our instructions, or which has been repaired or altered by anyone other than our authorized representative.

We shall not be liable for any contingent liabilities arising out of the improper function of any parts.

We make NO WARRANTY with respect to parts NOT of our manufacture, but we will carry out the terms of the warranties of their respective manufacturers.

For commercial and rental use the warranty period is for 30 days from date of purchase.

If you need any support for this product, please call Brave Products at (800) 350-8739. Have your model and serial number on-hand before calling.



# Parts

Item	Part No.	Description	Qty	Item	Part No.	Description	Qty
1	BR001321	Locknut, 1/2-13	3	23	BR001025	O-ring, Vented Fill Plug	1
2	BR021263	Weldment, Tank Hydraulic	1	24	BR001209 <sup>2</sup>	Bolt, 5/16-18 x 3/4" long	8
3	BR001272	Bolt, 1/2-13 x 4-1/2" long	3	25	BR007016 <sup>2</sup>	Fender	2
4	BR001764	Clip, Hairpin, 3/32"	2	26	BR001325 <sup>2</sup>	Locknut, 5/16-18	8
5	BR001494	Pin, Hitch, 1/2 x 4" long	2	27	BR012234 <sup>2</sup>	Bracket, Fender, RH	1
6	BR021242	Weldment, Base	1	28	BR012326 <sup>2</sup>	Bracket, Fender, LH	1
7	BR001021	Fill Plug, Vented	1				
8	BR008301B	Seal, Inside	2				
9	BR008301A	Bearing, Tapered Roller	4				
10	BR008301	Tire, 4.8" x 8"	2				
11	BR008301D	Washer, Thrust	2				
12	BR008301E	Nut, Spindle	2				
13	BR008301F	Key, Cotter, 1/8"	2				
14	BR008301G	Cap, Dust	2				
15	BR021225	Weldment, Front Leg	1				
16	BR001212	Bolt, 5/16-18 x 1 3/4" long	4				
17	BR001401	Washer, 5/16"	4				
18	BR001402	Lockwasher, 5/16"	4				
19	BR001303	Nut, 5/16-18	4				
20	BR001213	Bolt, 1/2-13 x 1-1/4" long	4				
21	—	Not Used					
22	BR001321	Locknut, 1/2-13	4				

<sup>2</sup> Part of Model VH0626 only.

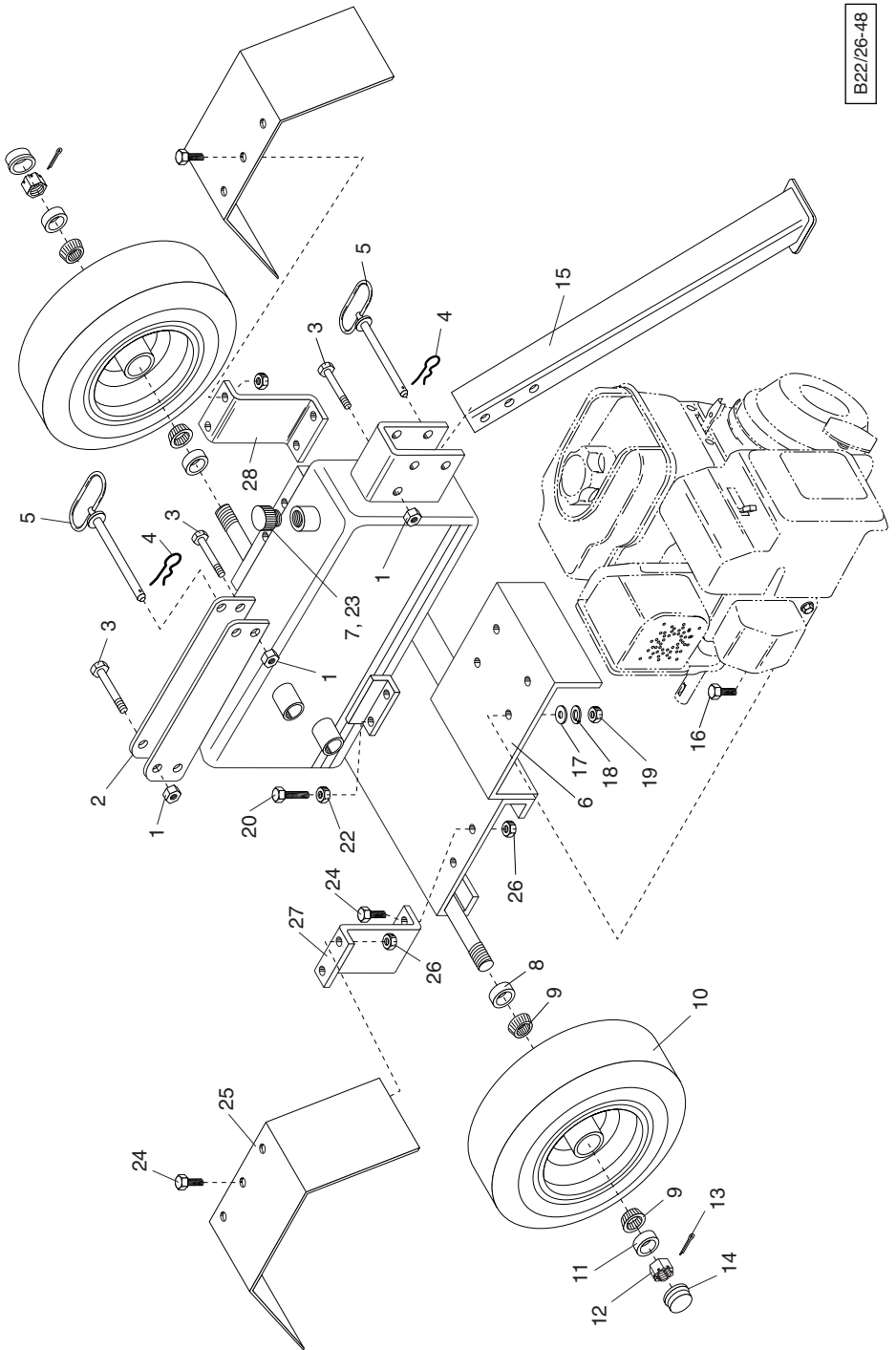

# Parts

Item	Part No.	Description	Qty
1	BR021262	Weldment, Rail	1
2	BR021163	Weldment, Slide Wedge	1
3	BR013102	Guide, Slide	2
4	BR013104	Retainer, Slide	2
5	BR001404	Lockwasher, 1/2"	6
6	BR001304	Nut, 1/2-13	6
7	BR001259	Bolt, Carriage, 1/2-13 x 2-1/2" long	6
8	BR001761	Pin, Cotter	1
9	BR001765	Slide Pin, 1/2 x 3" long	1
10	BR004057 <sup>1</sup>	Cylinder	1
	BR004056 <sup>2</sup>	Cylinder	
11	BR008531A	Pin, Grooved, 1" dia.	1
12	BR001705	Clip, Clevis Pin (Cylinder)	2
13	BR008540	Coupler, Hitch, 2"	1
14	BR001203	Bolt, 1/2-13 x 3" long	2
15	BR001321	Locknut, 1/2-13	2
16	BR008508	Chain Assembly	2
17	BR008511	Safety Quick-Link	1

<sup>1</sup> Part of Model VH0622 only.

<sup>2</sup> Part of Model VH0626 only.

B22/26-49

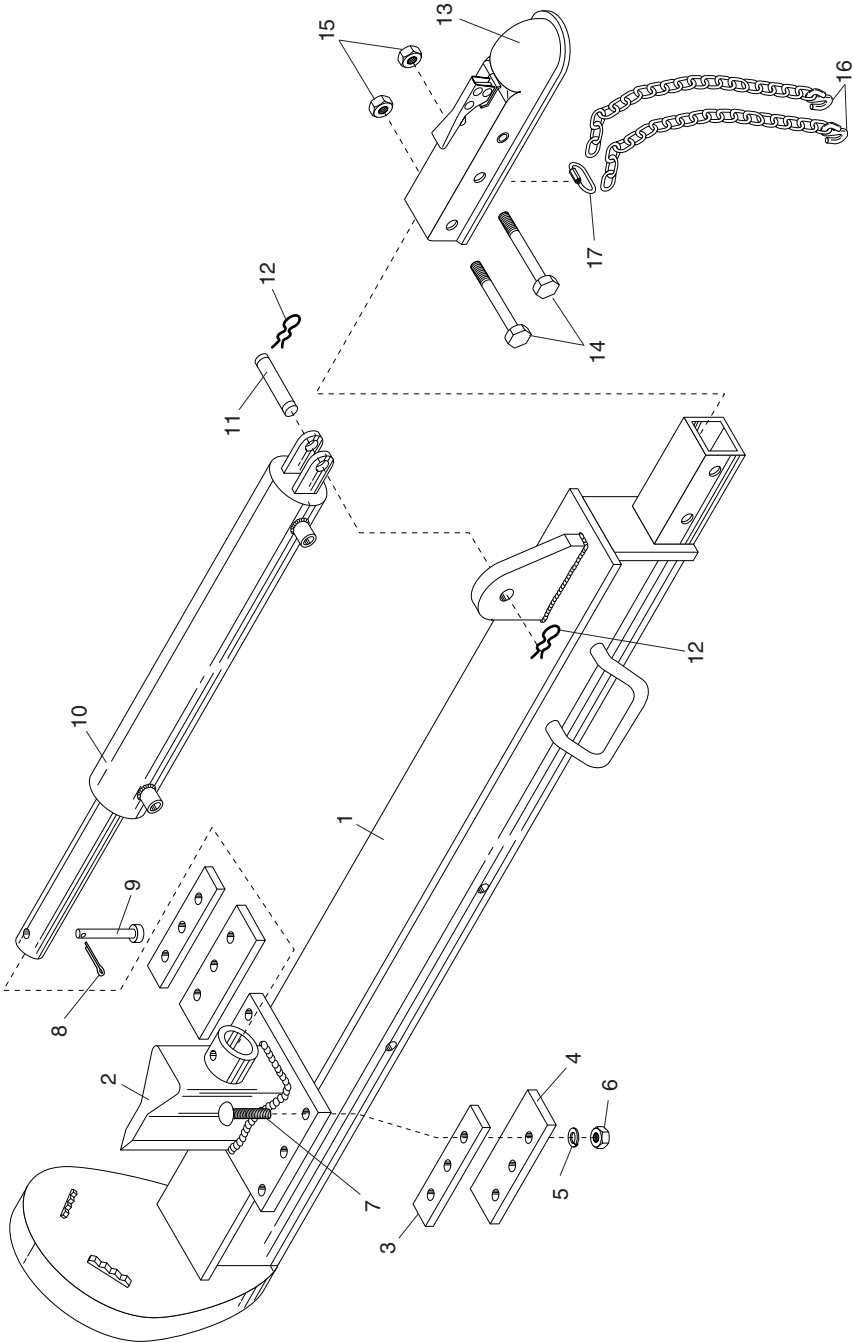

# Parts

Item	Part No.	Description	Qty	Item	Part No.	Description	Qty
1	BR003009 <sup>1</sup>	Engine, Briggs, 6.5 HP	1	12	BR001113	Element, Filter	1
	BR003013 <sup>2</sup>	Engine, Briggs, 8 HP		13	BR001112	Casting, Head Filter	
	BR003019 <sup>2</sup>	Engine, Honda, 9 HP, GX		14	BR001011	Fitting, Elbow, 90°	
2	BR010104 <sup>1,2</sup>	Key, Engine Shaft	1	15	BR004999	Clamp, Hose, No. 16	2
	BR010105 <sup>3</sup>	Key, Engine Shaft		16	BR005048	Hose, Low-Pressure, 3/4 x 35"	
3	BR001382 <sup>3</sup>	Screw, Set, 5/16-18	2	17	BR005055	Hose, High-Pressure	1
	BR001383 <sup>1,2</sup>	Screw, Set, 1/4-20		18	BR005080	Hose, Low-Pressure, 1 x 9"	
4	BR006002C <sup>1,2</sup>	Coupling, Engine	1	19	BR001017	Fitting, High-Pressure, 90°	1
	BR006001C <sup>3</sup>	Coupling, Engine		20	BR004165	Link, Chain	
5	BR006002B <sup>1,2</sup>	Spider	1	21	BR004214	Pin, Clevis, 1/4 x 1" long	1
	BR006001B <sup>3</sup>	Spider		22	BR004215	Pin, Cotter, 3/32 x 1/2" long	
6	BR006002D <sup>1,2</sup>	Coupling, Pump	1	23	BR004117A	Lever, Control	1
	BR006001D <sup>3</sup>	Coupling, Pump		24	BR004117	Valve	
7	BR020010 <sup>1,2</sup>	Flange, Engine	1	25	BR005001	Clamp, Hose, No. 12	2
	BR020110 <sup>3</sup>	Flange, Engine		26	BR001052	Fitting, Straight	
8	BR001402	Lockwasher, 5/16"	4	27	BR004002K	Fitting, 90° Elbow	1
	BR001266 <sup>1,2</sup>	Bolt, 5/16-24 x 3/4" long		28	BR004119	Hose, High-Pressure	
9	BR001265 <sup>3</sup>	Bolt, 5/16-24 x 1" long	4	29	BR001273 <sup>1</sup>	Bolt, 5/16-24 x 5 1/2" long	2
	BR002001MK <sup>1</sup>	Key, Pump Shaft (11 gpm)			HHC G5		
	BR002002MK <sup>2,3</sup>	Key, Pump Shaft (16 gpm)			Bolt, 5/16-24 x 6" long, HHC G5		
10	BR002001M <sup>1</sup>	Pump, Hydraulic	1				2
	BR002002M <sup>2,3</sup>	Pump, Hydraulic					

<sup>1</sup> Part of Model VH0622 only.

<sup>2</sup> Part of Model VH0626 only.

<sup>3</sup> Used with optional 9 HP GX Honda engine.

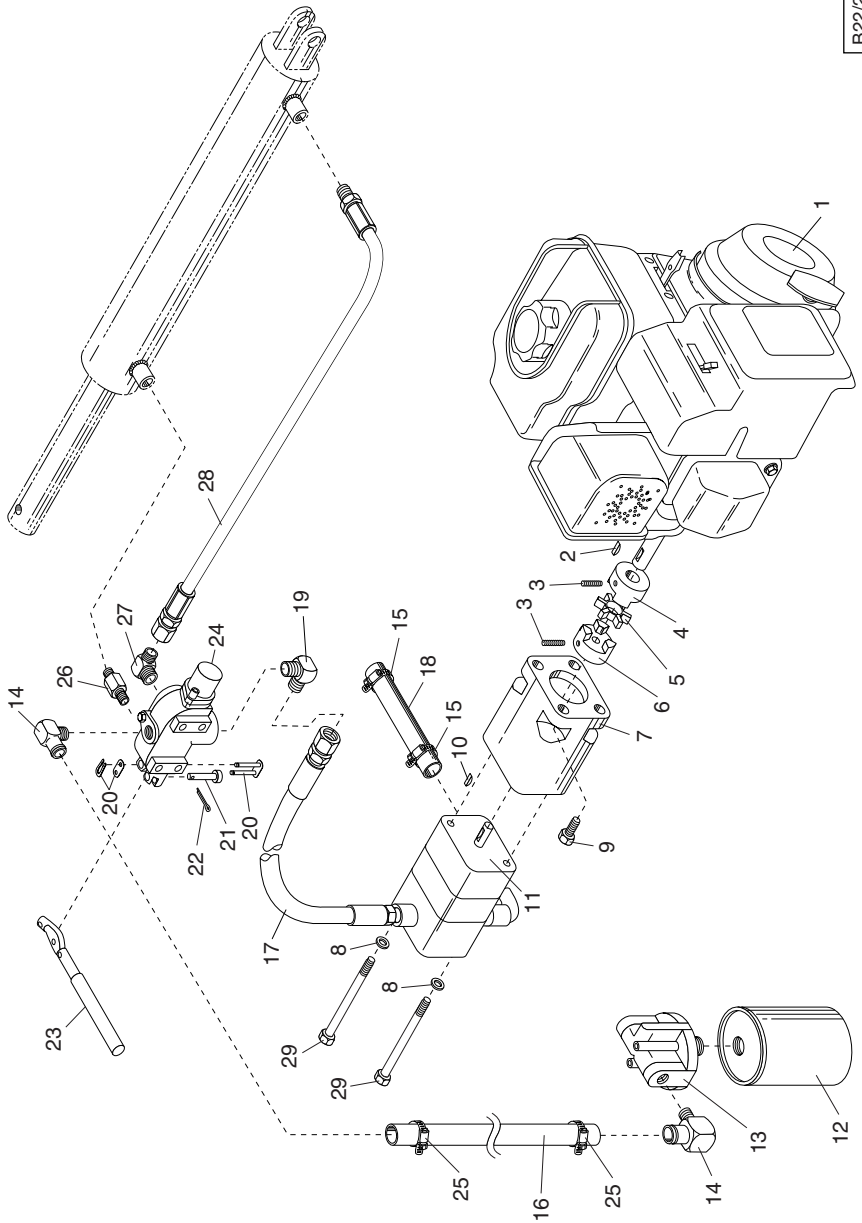

# Optional Attachments

These attachments are designed to fit both Brave 22 and 26 ton log splitters.

## Log Cradle (Part No. BR021181)

- ✓ Holds log in place on top of rail for faster splitting.
- ✓ Catches split logs - no more stooping to pick up the split pieces.
- ✓ Each shelf is infinitely adjustable up to 45 degrees to accommodate various sizes of logs.
- ✓ Mounts easily to H-beam rail - all hardware included, requires no drilling or welding on current model log splitters.

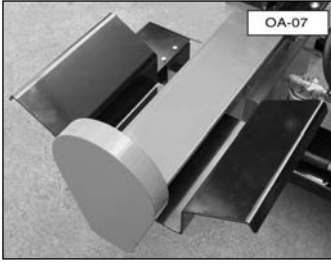

## Log Dislodger (Part No. BR021172)

- ✓ Helps eject any log that sticks to the splitting wedge.
- ✓ Protects control valve and other hydraulic components from damage.
- ✓ Rugged construction to last the life of your log splitter.
- ✓ Mounts easily to splitter rail - all hardware included, no drilling or welding required.

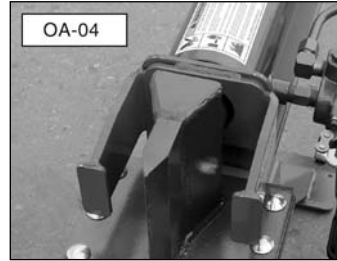
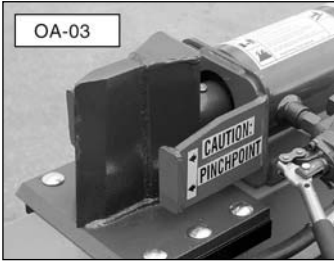

## Safety Flag Kit (BR012104)



- ✓ Improves visibility of log splitter when backing up or towing.
- ✓ Heavy-duty tapered fiberglass pole won't bend over at towing speeds.
- ✓ Installs in minutes, no drilling required.
- ✓ Mounting instructions included.

## Important Warranty Information

To activate your Brave Products' log splitter warranty, please fill out the information in the form below, clip out the form on the dotted line, insert into an envelope, and mail to:

Brave Products, Inc  
P.O. Box 577  
Streator, IL 61364-0577

---

### Brave Products' Log Splitter Warranty Information - Please Print -

Model:  VH0622  VH0626 SERIAL #: \_\_\_\_\_

OWNER'S NAME: \_\_\_\_\_

ADDRESS: \_\_\_\_\_

CITY: \_\_\_\_\_ STATE: \_\_\_\_\_ ZIP: \_\_\_\_\_

Purchased From: \_\_\_\_\_

Street Address: \_\_\_\_\_

City: \_\_\_\_\_ State: \_\_\_\_\_ Zip: \_\_\_\_\_

Your Signature: \_\_\_\_\_ Date: \_\_\_\_\_







**Brave Products, Inc.**  
**410 W. Broadway Ave.**  
**Streator, Illinois 61364-0577**  
**Phone: 815-672-8861 Fax: 815-672-9073**  
**E-mail: [sales@braveproducts.com](mailto:sales@braveproducts.com)**

**Web Site: [www.braveproducts.com](http://www.braveproducts.com)**