

See
Quick Reference
Guide on page one



BRAVE

PRODUCTS, INC.

Brave EZ Split 15

Horizontal Log Splitter

Model PCLS15



Patented

 **Made in U. S. A.**

Owner / Operator and Safety Manual

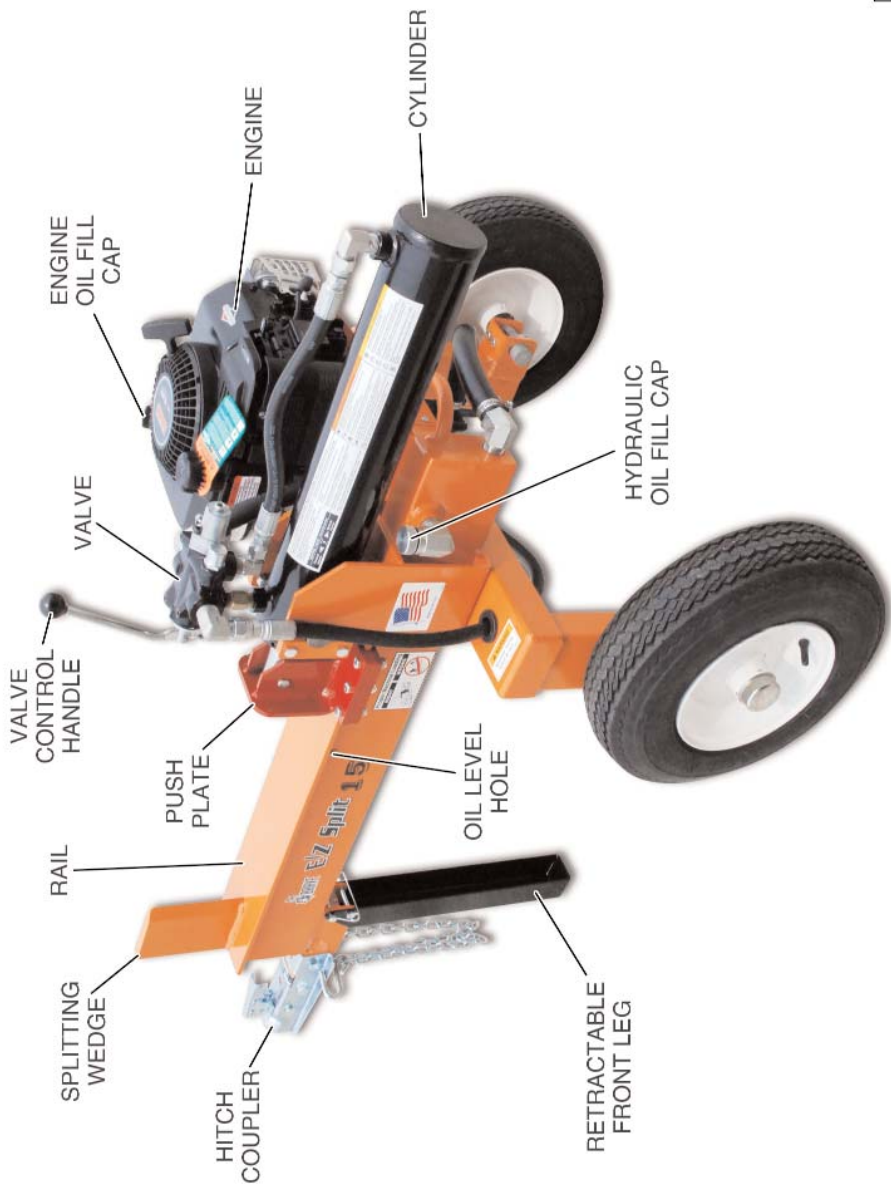

EZ Split 15 Quick Reference Guide

1. Safety Instructions

Do not attempt to assemble, operate, or maintain the log splitter unless you read and understand the instructions, precautions, and warnings in this manual. See pages 4-9.

2. Assembly Instructions

Follow the steps listed and assemble your EZ Split 15 log splitter. See pages 10-14.

3. Initial Start-Up Procedure

These instructions include the proper fluids to fill the hydraulic tank, engine crankcase, and engine fuel tank. Follow the instructions exactly. See pages 15-16.

4. Towing

Read and understand completely before towing your EZ Split 15. See pages 17.

5. Operation

Read and understand completely before using your EZ Split 15 to split wood. See pages 18-23.

6. Inspection and Maintenance

Follow these instructions for inspection and maintenance of your EZ Split 15. See pages 23-28.

7. Serial Number

Write the serial number and date of purchase in the space available at the bottom of this page.

8. Warranty Card

Fill out and return the warranty card to Brave Products, Inc. See page 41.

Serial Number _____

Date-of-Purchase _____

Please enter the serial number and purchase date of your log splitter in the space provided. Keep this manual for future reference.

IRON & OAK

BRAVE
PRODUCTS, INC.
Streator, IL



SERIAL No.

Made in U.S.A.

NOTE: Brave Products reserves the right to make technical changes for product improvement. This manual may contain illustrations and photographs, for demonstration purposes, which slightly deviate from the actual product design.

Contents

Introduction	3
Safety	4
Safety Alert Symbol	4
General	4
Personal Protection	5
Towing	5
Worksite Safety	6
Operating Safety	6
Log Splitting Safety	8
Refueling	8
Preventing Fires	8
Maintenance and Repair	9
Assembly Instructions	9
Start-Up Procedure	15
Towing	17
Operation	18
General Maintenance Check (before operating)	22
Oil Level Check	22
Inspection and Maintenance	23
Inspection	23
Oil Pump Installation	24
Engine Service & Storage	24
Hydraulic Oil Change	25
Tire Pressure	28
Specifications	29
Mechanical Specifications	29
Hydraulic Specifications	29
Hydraulic Oil Specifications (non foaming)	29
Troubleshooting	30
Decals	31
Optional Attachment	35
Safety Flag (Part Number BR012105)	35
Parts	36
Warranty	40
Warranty Card	41

Introduction

Congratulations on your purchase of a new Brave log splitter.

The Brave EZ Split 15 log splitter is powerful, portable, easy to operate, and stores in a minimum of space. It is the perfect log splitter for homeowners with fireplaces and wood stoves and is towable to work sites behind a car, van, SUV, or pick-up truck.

With a powerful gasoline engine, 15 tons of splitting force, and an 8 second cycle time, the EZ Split 15 will handle most of your log splitting needs. The heavy-duty frame will handle logs up to 18 inches (45.7 cm) long and an attractive powder coat finish provides the finest protection against the elements. Brave's rigid quality control and component testing help ensure years of productive, reliable service.

For additional information, contact us at:

Brave Products, Inc.
1705 N. Shabbona St.
Streator, Illinois 61364-1301
Phone: (800) 350-8739
Fax: (815) 672-9073
E-mail: sales@braveproducts.com
Web Site: www.braveproducts.com



EZ15-03

Safety

Safety Alert Symbol

The safety alert symbol  is used to identify safety information about hazards that can result in personal injury or death.

A signal word (WARNING or CAUTION) is used with the alert symbol to indicate the likelihood and the potential severity of injury. In addition, a hazard symbol may be used to represent the type of hazard.



WARNING indicates a hazard which, if not avoided, **could result in death or serious injury.**



CAUTION indicates a hazard which, if not avoided, **might result in minor or moderate injury.**

IMPORTANT NOTICE indicates a situation that **could result in damage to the log splitter, cylinder, or engine.**

The following is a list of safety rules you must follow in order to use your log splitter safely.

General



To avoid personal injury or death, carefully read and understand all instructions pertaining to the Brave Products' log splitter.

Do not attempt to assemble, operate, or maintain the log splitter unless you read and understand the instructions, precautions, and warnings in this manual. If any doubt or question arises about the correct or safe method of performing any steps found in this or other Brave Products' manuals, contact your Brave Products' dealer or call the Sales and Service representatives at our main headquarters. Proper care is your responsibility.



Accidents can often be avoided by being alert and recognizing potentially hazardous situations. Any individuals operating, maintaining, or repairing products manufactured by Brave Products should have the necessary training, skills, and tools required to perform these functions properly and safely. The safety information in this manual serves as a basic guide in an attempt to prevent injury or death.

Brave Products cannot anticipate every possible circumstance that might involve a potential hazard. The warnings in this manual and on the product itself are, therefore, not all inclusive. If tools, procedures, work methods, or operating techniques that are not specifically mentioned by Brave Products are used, you must satisfy yourself that they are safe for you and for others. Make sure the log splitter will not be damaged or made unsafe by any operation, lubrication, maintenance, or repair procedures that you choose.

DO NOT proceed if any doubt arises about the correct or safe method of performing anything found in this or other Brave Products' manuals. Seek out expert assistance from a qualified person before continuing.



CALIFORNIA PROPOSITION 65: Engine exhaust from this product contains chemicals known to the State of California to cause cancer, birth defects, or other reproductive harm.



SPARK ARRESTORS: Certain states and federal jurisdictions have specific laws prohibiting the use of an internal combustion engine without an approved spark arrestor. It is the users responsibility to make sure the engine complies with laws that apply in the state the log splitter is used. Check local laws and refer to the engine manual for more information on equipping the engine with a required spark arrestor.

Personal Protection



To avoid personal injury or death, carefully read and understand all instructions pertaining to the log splitter, including the engine manufacturer's operating and maintenance instruction manual.



Always wear protective gear, such as safety goggles, face shield, and hearing protection.



Always wear protective, tight fitting gloves (without drawstrings or loose cuffs), and steel toed shoes.



To prevent injury, make sure all decals are attached to the log splitter and are legible at all times.

Towing



Raise and lock the front support leg in the transport position, before towing.



ALWAYS check before towing to make certain your log splitter is correctly and securely attached to the towing vehicle. Be sure that the ball hitch you are using is the proper size for the hitch coupler on the log splitter (refer to the "Specification" section.)



Be sure both safety chains are properly hooked to the vehicle, leaving enough slack for turning.



ALWAYS allow for added length of the log splitter when turning, parking, crossing intersections, and in all driving situations.

Safety



It is **NOT** recommended that you back up with the log splitter connected to the tow vehicle. The log splitter could easily jackknife, resulting in damage to the log splitter and/or tow vehicle.



ALWAYS disconnect your log splitter from the tow vehicle before operating the log splitter.



NEVER exceed 35 m.p.h. (56 kph) when towing your log splitter. Obey all state and local regulations when towing on state and local roads and highways. Adjust your speed for terrain and conditions, as needed. Be extra cautious when towing over rough terrain, especially over a railroad crossing.



NEVER allow anyone to sit or ride on your log splitter. **NEVER** carry any cargo or wood on your log splitter.

Worksite Safety



NEVER operate your log splitter on slippery, wet, muddy, or icy surfaces. The location you choose should be solid, flat, dry, and free from any tall grass, brush, or other interferences.



NEVER operate the engine in an enclosed area. Exhaust fumes contain carbon monoxide that can be deadly when inhaled. Make sure the area is well ventilated.



Always block the wheels to prevent movement of the log splitter, while in operation .



To avoid tripping, do not leave tools, logs, or other components laying around the work area.



NEVER use your log splitter at night.

Operating Safety



ONLY ALLOW ONE (1) PERSON TO LOAD AND OPERATE THE LOG SPLITTER.



Do not allow any person to operate the log splitter until after they have read and understand the safe operating instructions contained in this manual.



Only allow adults to operate your log splitter. No one under the age of 18 should be allowed to operate the log splitter.



Always keep bystanders, including children and pets, at least twenty-five (25) feet away from the work area. Only the operator should stand near the equipment and only within the safe operating area prescribed in this manual (refer to the photos on safe and unsafe operating zones in the “Operation” section.)



When the ram of the log splitter is in the return mode, keep your hands off the machine — the log splitter is designed to automatically stop when the cylinder is fully retracted.



ALWAYS disconnect the spark plug wire when the log splitter is not in operation.



Do not, under any circumstances, alter your log splitter. This equipment was designed and engineered to be used in accordance with the operating instructions. Altering the equipment, or using the equipment in such a way as to circumvent its design capabilities and capacities, could result in serious or fatal injury and WILL VOID THE WARRANTY.



Never operate, or allow anyone else to operate this equipment while under the influence of medication, drugs, or alcohol.



Never wear loose clothing or jewelry that may get caught or become entangled in the log splitter.



NEVER place hands or feet between log and splitting wedge or between log and ram during the forward or reverse stroke.



DO NOT STRADDLE OR REACH ACROSS THE SPLITTING AREA WHEN OPERATING THE LOG SPLITTER.



Do not step over your log splitter when the engine is running because you may trip or accidentally engage the ram.



NEVER attempt to load your log splitter while the ram is in motion.



Only use your hand to operate the control lever. NEVER use your foot, knee, a rope, or any other extension device.

Safety

Log Splitting Safety



Always keep your fingers away from cracks that open in the log during the splitting operation.



ALWAYS make sure that both ends of the log you are splitting are cut as square as possible. This will prevent the log from sliding out of position while under pressure. Logs should be 18 inches or shorter in length.



Never pile logs to be split in a manner that will cause you to reach across the log splitter.

Refueling



DO NOT fill the gas tank while the engine is hot or running. Allow time for the engine to cool down before refueling.



ONLY refuel the log splitter outdoors in a clear area. Avoid breathing gas fumes or spilling gasoline on the engine. ALWAYS use an approved fuel container to carry gasoline.



ALWAYS replace the log splitter gas cap and the fuel container cap securely.



NEVER smoke or have an open flame while refueling the log splitter. Gasoline, oil, and even gas fumes can explode. Be careful not to spill any fuel on the engine.



If gasoline is spilled, move the machine away from the area of the spill and avoid creating any source of ignition. Clean up the spill and make sure any gasoline-soaked rags are disposed of properly.



Always store gasoline in an approved, tightly-sealed container. Store the container in a cool, dry place. Do not store the container in a house or near any heating appliance.

Preventing Fires

Important Notice

The log splitter is equipped with an internal combustion engine and should not be used on or near any unimproved forest-covered, brush-covered, or grass-covered land unless the engine's exhaust system is equipped with a spark arrester meeting local or state laws (if any). If a spark arrester is used, it should be maintained in effective working order by the owner and/or operator.



Take a class B fire extinguisher with you when operating the log splitter in dry areas as a precautionary measure against possible flying sparks.



NEVER operate the log splitter near a flame or spark. NEVER smoke while operating the log splitter. Oil and gasoline are flammable and can explode.



SPARK ARRESTORS: Certain states and federal jurisdictions have specific laws prohibiting the use of an internal combustion engine without an approved spark arrestor. It is the users responsibility to make sure the engine complies with laws that apply in the state the log splitter is used. Check local laws and refer to the engine manual for more information on equipping the engine with a required spark arrestor.

Maintenance and Repair

For more information on maintaining the log splitter, refer to the Inspection and Maintenance section in this manual.



Follow all safety rules. Most accidents involving the operation, maintenance, or repair of products occur because the owner/operator failed to observe basic safety rules or operating instructions.



ALWAYS inspect your log splitter before each use. Make sure all nuts, bolts, screws, hydraulic fittings, hose clamps, etc. are securely tightened.



ALWAYS check the oil level in the hydraulic oil tank and engine reservoir before each use.



NEVER operate your log splitter when it is in need of repair or is in poor mechanical condition.



NEVER tamper with the engine to run it at excessive speeds. The maximum engine speed is preset and is within safety limits.



NEVER make alterations to your log splitter in any manner. Such alterations may cause the log splitter to become unsafe and **WILL VOID THE WARRANTY.**



NEVER attach a rope or extension to the control lever or add width or height to the splitting wedge. Such **ALTERATIONS** may cause the log splitter to become **UNSAFE** and **WILL VOID THE WARRANTY.**



ALWAYS clean the unit after each use. If possible, store the unit inside or cover it completely if stored outside.

Assembly Instructions

Required Tools

- Claw hammer
- Flat head screwdriver
- 10 inch Crescent wrench
- Two 9/16" open-end wrenches
- Long-neck funnel
- Band cutters
- Phillips head screwdriver
- Needlenose pliers
- Two 3/4" open-end wrenches

Required Fluids

- Motor oil - per engine manufacturer's specifications.
- Engine fuel - lead-free gasoline.
- Hydraulic oil (non-foaming)
 - Extremely cold weather conditions: 10W tractor hydraulic oil or Dexron III transmission fluid
 - Extremely warm weather conditions: 30W tractor hydraulic oil

Do not mix hydraulic oil and transmission fluid. Use one or the other. For more information, refer to the Start-up Procedure section in this manual.

Instructions

1. Uncrate the log splitter.
 - a. Use band cutters to carefully cut and remove banding from around the crate. Discard the banding.
 - b. Use a claw hammer to remove the top and sides of the shipping crate.
2. Remove the parts carton from the shipping pallet.



Assembly Instructions

3. Open the parts carton and make sure you have the following parts.

Item	Description	Qty
1	Tire / Axle Assembly ¹	2
2	Bolt, 3/8-16 x 3" long ¹	4
3	Locknut, 3/8-16 ¹	4
4	Hitch Coupler	1
5	Bolt, 1/2-13 x 3.5" long	2
6	Locknut, 1/2-13	2
7	Safety Chains	2
8	Safety Chain Quick Link	1
9	Cylinder Retainer Plate	2
10	Bolt, 3/8-16 x 1" long	4
11	Locknut, 3/8-16	4

¹ One bolt and locknut connects axles during shipping. Save bolt and locknut for reuse.



4. Remove shipping materials.

- Use 10" Crescent wrench to remove the lag bolt securing the EZ Split 15 tongue to the shipping pallet. Discard the lag bolt.
- Use band cutters to remove banding (not shown) securing the rear of the log splitter to the shipping pallet. Discard the banding.



5. Use two 9/16 inch wrenches to unbolt the tire assembly axles.

Note: Save the bolt (2) and nut (3) for reuse during tire assembly installation.

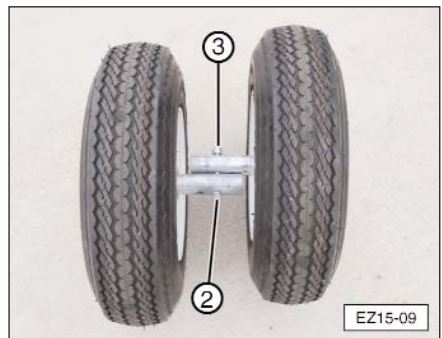

Assembly Instructions

6. Get assistance to raise one side of the EZ Split 15 frame and insert the tire assembly axle into the receiver hole in the frame.



7. Attach the axle to the EZ Split 15 frame with two 3/8-16 x 3" long bolts (2) and two 3/8-16" locknuts (3). Use two 9/16 inch wrenches to completely tighten the bolts and locknuts.

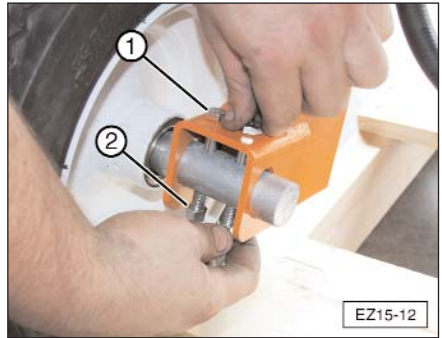

8. Repeat this procedure to install the remaining tire assembly onto the opposite side of the EZ Split 15 frame.



9. Carefully roll the log splitter off of the shipping pallet. Remove lock pin (A), lower front leg (B) and insert the lock pin to secure the front leg in the down position, as shown.

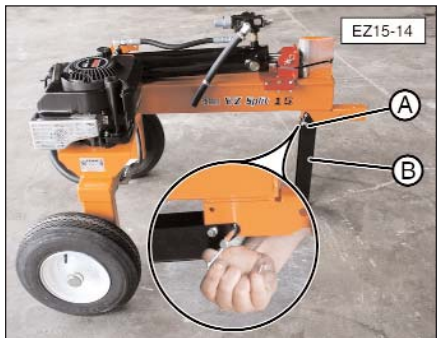

Assembly Instructions

10. Use band cutters to cut the band securing the push plate. Remove and discard the shrink wrap and cardboard from the splitting wedge.



11. Pull back on the cylinder and slide the trunnion pins into the mounting bracket, as shown.

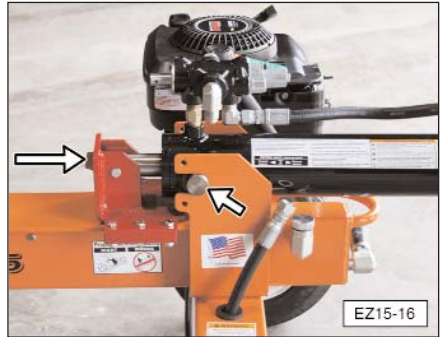

12. Install two retaining plates (9) using four 3/8-16 x 1" long hex bolts (10) and 3/8-16" locknuts (11) (not shown). Tighten the nuts securely using two 9/16 inch wrenches.

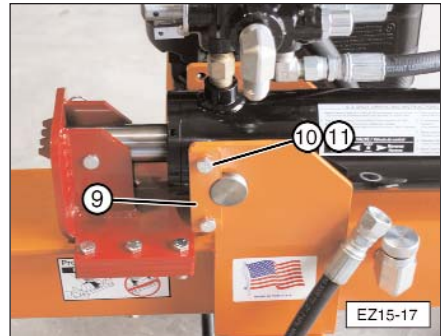

13. Connect high pressure hose (C) to the control valve fitting (D). Securely tighten the hose fitting with 10" Crescent wrench.

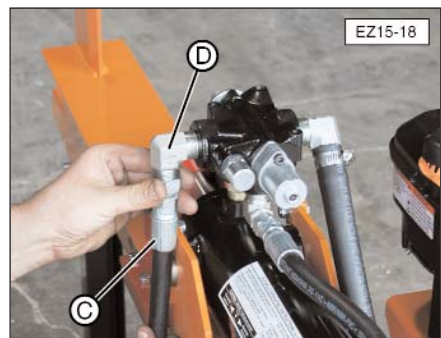

Assembly Instructions

14. Loosen hose clamp (E) and slide it down low pressure hose (F). Push the hose onto tube (G) and securely tighten the hose clamp with a flathead screwdriver.

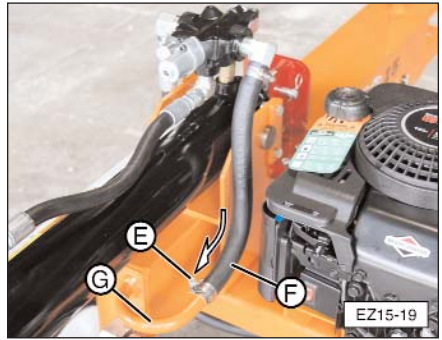

15. Link the ends of safety chains (7) together with safety quick link (8) and tighten the link's locknut with 10" Crescent wrench.



16. Place the hitch coupler over the tongue arm, align the holes and insert 1/2-13 x 3.5" bolt (5) through the back hole. Hold the safety chain quick link in the tongue and insert 1/2-13 x 3.5" bolt (5) through quick link and coupler, as shown. Secure bolts with two 1/2-13" locknuts (6) and tighten completely.

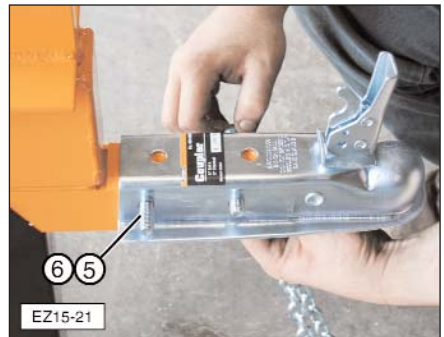

17. Attach the valve control handle to the hydraulic control valve.

- Install clevis pin (H) and hairpin clip (J) through the bottom hole on the valve.
- With handle (I) angled back, insert the forked end over pin (H).
- Align the hole in the handle with the top hole in the valve and insert clevis pin and hairpin clip (J).

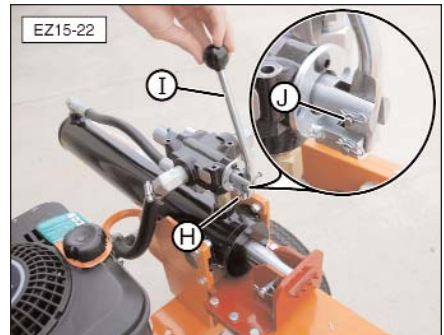

Important Notice

Read the Engine's Operating & Maintenance Instructions and follow the instructions listed below before starting or operating your log splitter. Failure to do so may result in engine and hydraulic pump damage.

NOTE: Place a clean container under oil level hole to catch any overflow of oil. Do not allow excess oil to spill onto the ground.

1. Remove the fill cap and oil level screw from the oil tank. Using a long-neck funnel, SLOWLY pour, approximately 6 quarts (5.7 liters) of the selected oil into oil fill opening (K) until it flows from oil level hole (L). Do not mix fluids, use only one type. Re-install the fill cap and oil level screw.

Hot weather - SAE 30 tractor hydraulic oil
Cold weather - SAE 10 tractor hydraulic oil
or Dexron III automatic transmission fluid

NOTE: The total hydraulic oil capacity for this unit is 9 quarts (8.5 liters). The remaining 3 quarts (2.8 liters) of oil will be added in Step 8.

2. Lubricate the underside edges of the rail with clean grease. This will help to prevent wear between the slide plates and the rail.
3. Fill the engine's crankcase with the engine manufacturer's recommended oil. Pour slowly and fill to the manufacturer's recommended level. Refer to the Oil Chart in the engine manual for different viscosities and types of oil to use for different temperatures.

NOTE: Various engines used on the EZ Split 15 may have the oil fill at different locations. For more information on oil fill locations, refer to the engine manual.

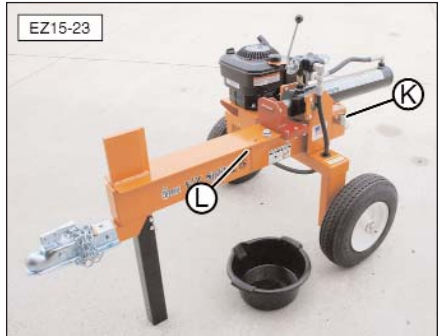

Start-up Procedure

WARNING



To prevent a fire hazard or possible explosion which could result in serious injury, do not smoke or have open flames when refueling the engine. Do not spill fuel. If fuel should spill, quickly wipe up the spill and move the log splitter away from the area before continuing. Make sure gasoline-soaked rags are disposed of properly.

4. Fill the engine's fuel tank with fresh, clean, lead-free automotive gasoline. Fill to approximately 1-1/2" below top of neck to allow for expansion. The supplied engine is a 4-cycle engine, so do not mix oil with the fuel.
5. Now start the engine according to the engine manufacturer's instruction. (Refer to the engine manual.) Allow the engine to warm up.

WARNING



Keep all body parts away from the slide area when cycling the cylinder.

6. Push the valve control handle, with one hand, to the forward (extend) position (towards the front of the cylinder). When the push plate is fully extended, push the valve control handle backwards to the retract position and retract the cylinder piston. The cylinder valve will automatically stop the cylinder from retracting when it reaches the end of its stroke. Fully cycle the cylinder 2 to 3 times, finishing with cylinder in the retracted position.

NOTE: Extending and retracting the cylinder piston draws the hydraulic fluid through the system and expels any trapped air in the system.

7. Turn off the engine.
8. Make sure the log splitter is flat and level. Remove the fill cap and oil level screw and slowly add approximately 3 quarts (2.8 liters) of additional oil just until it runs from the oil level hole. Allow enough time for excess oil to drain from oil level hole. Re-install fill cap and oil level screw making sure O-rings are in place.
9. Check all fittings and hoses for leaks and tighten as needed. Your EZ Split 15 log splitter is now ready to use.

⚠ WARNING

It is the responsibility of the driver to make sure the log splitter is securely attached to the vehicle. Failure to securely attach the log splitter can cause loss of control of the vehicle or the log splitter becoming separated from the towing vehicle, resulting in serious injury or death.

Maximum Towing Speed Limit — 35 mph. (56 kph). Your log splitter is built on a solid, unsuspended axle. To prevent damage or possible loss of vehicle control, use extreme caution when towing and do not exceed a vehicle speed of 35 mph (56 kph), especially when driving on a bumpy road.

NOTE: Always check the log splitter tire pressure before towing. Refer to the tire manufacturer's specifications.

1. Position the hitch on your EZ Split 15 log splitter near the tow ball on the vehicle and pull coupler (4) latch assembly UPWARD to the OPEN position.
2. Lift the tongue, remove lock pin (A), and fold front leg (B) to the tow position. Insert the lock pin. Attach towing safety chains (7) to the tow vehicle.
3. Position the hitch on the tow ball of your vehicle and push DOWN on coupler (4) latch. Pull UP on the tongue arm to make sure the hitch is secure. Insert a customer supplied lock pin (not shown) into the latch assembly. Attach towing safety chains (7) to the tow vehicle.

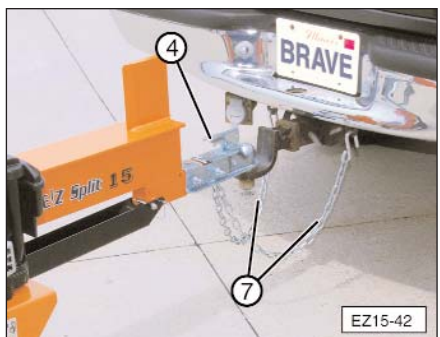
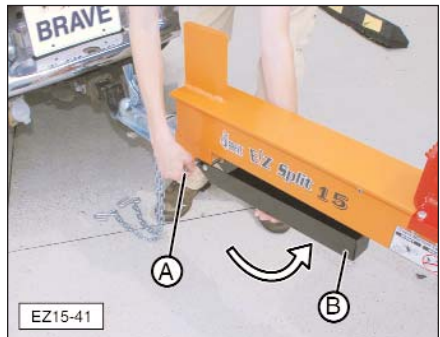
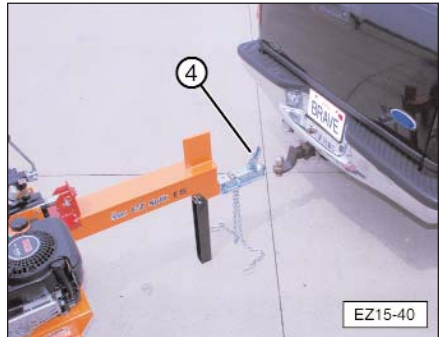

Important Notice

Do not back up with the log splitter attached. The short tongue length can cause it to jackknife quickly, resulting in damage to the log splitter and/or tow vehicle.

Operation

⚠ WARNING



Do not attempt to operate the log splitter without fully understanding all instructions, safety precautions, and warnings. If any doubt or question arises about the correct or safe method of performing anything found in this or other Brave Products' manuals, contact your Brave Products' dealer or call the Sales and Service representatives at our main headquarters. Proper care is your responsibility.



Before loading and operating the log splitter, put on the proper protective gear, such as safety goggles, face shield, hearing protection (ear muffs or ear plugs), tight-fitting gloves (without drawstrings or loose cuffs), and steel-toed shoes.

When operating the log splitter, make sure you are in the **safe operating zone**, as shown in these pictures. You must stay in the **safe operating zone** at all times when the pusher plate is in motion (whether extending or retracting). Never place any part of your body into a position which would cause an unsafe operating condition.

1. Make sure you read all the recommendations in the "Safety" section, before using the log splitter.
2. Position your log splitter on solid, flat, dry ground. Block the wheels to prevent unwanted movement of the log splitter during operation.
3. Start the engine using the instructions from the engine manual. If the log splitter has not been running (cold engine), warm up the engine by running the engine for 3 to 4 minutes, before operating the hydraulic system.



⚠ WARNING



Make sure you stay clear from the engine's exhaust. Hot exhaust is intense and can cause serious injury.

4. Refer to the following photos for the correct methods of splitting logs. Never split a log using an incorrect or unsafe method.

- a. Place a log on the log splitter. Grasp the log on the sides near the middle of the block. Center the log, side-to-side, on the rail of the log splitter, making sure that the cut end is against the splitting wedge.



⚠ WARNING



Do not place your hands on the ends of the log when loading the log splitter. This is a very UNSAFE method and could result in serious injury to your hands.



Proper Machine Loading

RIGHT

WRONG

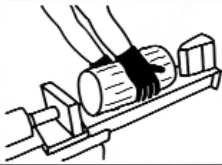

⚠ WARNING



Do not reach or step across the rail while the log splitter is running. This is a very UNSAFE method which could cause personal injury or even death.



Operation

- b. Make sure both ends of the log you are splitting are cut as square as possible. This will prevent the log from sliding out of position while under pressure. All logs should be 18" (45.7 cm) long or shorter.



⚠ CAUTION

Never attempt to split wood across the grain. The log splitter was not designed for cross-grain splitting; doing so will damage the log splitter and may cause personal injury.



5. Stand to the side, away from the engine, and use only your hand to push the control lever forward (towards the log). If the log moves, before it is contacted by the pusher plate, release the control lever and then reposition the log. Operate the log splitter only when in the **safe operating area**, as shown in the picture.



⚠ CAUTION



If you find you must hold the log until the pusher plate touches it and holds it in place, be very careful not to put your hand between the log and the pusher plate or the log and the splitting wedge. If you must, hold the log on top and in the middle. Remove your hand immediately when the pusher plate engages the log. Never use your knee or any extension device to operate the valve control handle.



6. Hold the control lever, extending the pusher plate, until the log is split or the cylinder rod stops at its maximum travel position. Stop the log splitter (forward movement), at any point in the splitting process, if you feel an unsafe log splitting condition is occurring. As the log is being split, DO NOT reach forward and attempt to catch the split wood — let it fall to the ground.

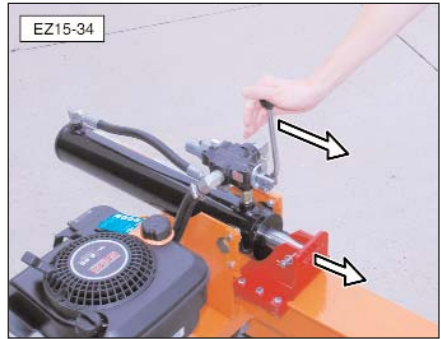

7. Once the log is split or the pusher plate reaches its full forward travel, pull back on the control lever to the full retract position. Release the control lever and the ram of the cylinder will automatically retract into the cylinder.



NOTE: It is not necessary to hold the control lever as the cylinder retracts. When the cylinder is fully retracted, the control valve will automatically shift to a neutral position.

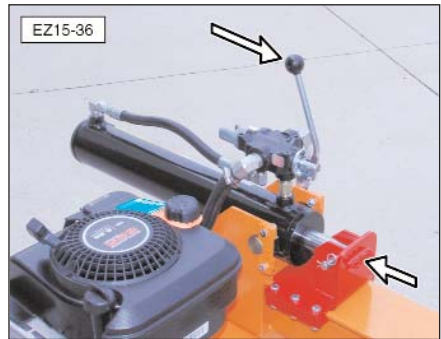

⚠ CAUTION



Depending on the type of wood being split, a log may not always split into two pieces and fall to the ground. If a log sticks to the wedge or pusher plate, place the valve handle in the neutral position (stop the pusher plate from retracting), stop the engine, and carefully remove the log from the wedge or pusher plate. Allowing the log to remain attached to the pusher plate when it is fully retracted could lead to possible injury and/or damage to the log splitter.

Operation

- DO NOT** load another log or remove split pieces until the pusher plate has completely stopped and the control handle automatically returns to the neutral position.

Splitting Large Logs

When splitting a large log, or one in which the wood is extremely tough or stringy (such as elm), the first pass through the splitter may not split the log into two sections. If this happens, turn the log and split off small sections. Repeat this process as necessary to split the entire log.



Inspection and Maintenance

General Maintenance Check (before operating)

The hydraulic system (hoses, cylinder, and pump) should be carefully inspected before each use. Also, inspect the mechanical parts at the same time. Make sure all clamps, nuts, bolts, fittings, etc. are properly installed and tightened.

Oil Level Check

⚠ CAUTION



Do not remove the oil level screw or fill cap from the hydraulic tank or reservoir while the log splitter is running. Hot oil, under pressure, could be expelled resulting in serious injury. Turn off the engine and allow the log splitter to cool for a few minutes to relieve pressure before checking the hydraulic oil level.

It is critical that the proper hydraulic oil level is maintained and the oil level should be checked periodically. Be sure the EZ Split 15 is on a flat, level surface before checking the oil level.

- Place a clean container under oil level hole to catch any overflow of oil. Do not allow excess oil to spill onto the ground.

⚠ WARNING



To prevent a fire hazard or possible explosion which could result in serious injury, do not smoke or have open flames when checking the hydraulic oil. Take care not to spill oil. If oil should spill, quickly wipe up the spill and move the log splitter away from the area. Make sure oil-soaked rags are properly disposed of.

2. Remove the screw from the side of the oil tank. If a small amount of oil does not run from oil level hole (L), the oil level is low.
3. Remove the fill cap and SLOWLY pour oil into fitting (K) until it runs from oil level hole (L). Allow enough time for excess oil to drain from the oil level hole.
4. Install the screw and fill cap (do not over tighten) making sure O-rings are in place. Clean up any spilled oil and dispose of oil-soaked rags properly.

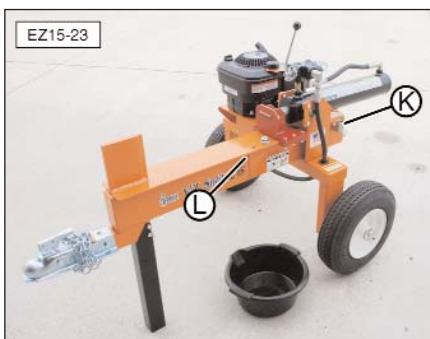

Inspection

⚠ WARNING



Do not check for high pressure oil leaks with your hand. Leaks can be located by passing a piece of cardboard or wood around the suspected leak and looking for discoloration. High-pressure fluid escaping from a very small hole can be almost invisible. Escaping fluid under pressure can have sufficient force to penetrate skin, causing serious injury or even death. If fluid is injected into your skin, it must be treated immediately by a doctor familiar with this type of injury.

Inspection and Maintenance

Always replace frayed, kinked, or cracked hoses and/or other damaged hydraulic components with Brave Products' authorized parts and components specified in the "Parts" section of this manual. Replacement parts from secondary suppliers (not original Brave replacement parts) can lead to product damage and/or personal injury, and WILL VOID THE WARRANTY.

Should it become necessary to loosen or remove any hydraulic fitting or line, be sure to relieve all hydraulic pressure by shutting off the engine, removing spark plug wire, and moving the valve control handle back and forth several times until no cylinder movement is visible.

Oil Pump Installation

If the hydraulic oil pump is removed and/or replaced, the four bolts on the bottom of the pump must be properly tightened.

Two bolts on the bottom of the hydraulic pump hold the pump sections together and two long bolts (1) and locknuts (2) attach the pump to the log splitter. All four bolts must be tightened to 13.5 ft. lbs (18.3 N·m).

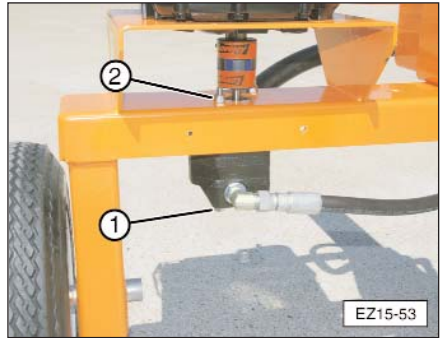

Important Notice

Improper tightening of pump bolts can cause pump failure.

Engine Service & Storage

Refer to the engine manufacturers manual for engine maintenance, repair, and engine storage. No special procedures are required for the hydraulic system before storing the log splitter.

NOTE: To gain access to the engine oil drain plug, it may be necessary to remove a engine-to-pump-coupling cover plate.

⚠ WARNING



The engine-to-pump-coupling rotates at a high rate of speed. To avoid serious injury, do not run the engine with cover plates removed. Cover plates must be reinstalled before operating the log splitter.

1. Remove the spark plug wire to prevent the engine from starting.
2. Use two 3/8 inch wrenches to remove bolts (M) and locknuts (N) securing cover plate (O).
3. After draining the engine oil and replacing the drain plug, reinstall cover plate (O). Tighten bolts (M) and nuts (N) securely and connect the spark plug wire.

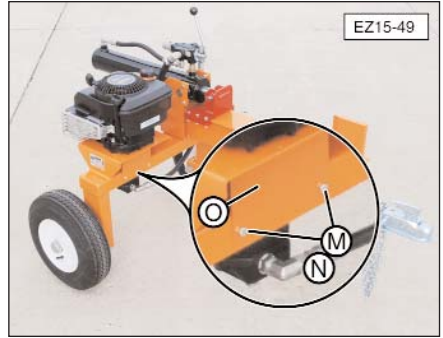

Hydraulic Oil Change

Brave Products recommends an oil change every 100 hours of operation. Refer to the "Specifications" section in this manual for the type and quantity of oil.

Important Notice

Never run the log splitter unless the hydraulic oil tank is full.

1. Drain the hydraulic tank.
 - a. Place a waste oil container under inlet hose. (P)
 - b. Loosen clamp (Q) and slide hose (P) off of the hydraulic pump hose fitting.
 - c. Completely drain the tank.
 - d. Reconnect inlet hose (P) to the pump.
 - e. Make sure hose clamp (Q) is completely tightened.

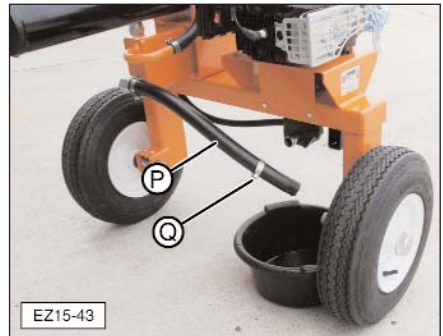

Inspection and Maintenance

2. Drain the head end of the cylinder.

- a. Remove spark plug wire (R) and spark plug (S) to help reduce the back pressure on the engine and to prevent it from starting.

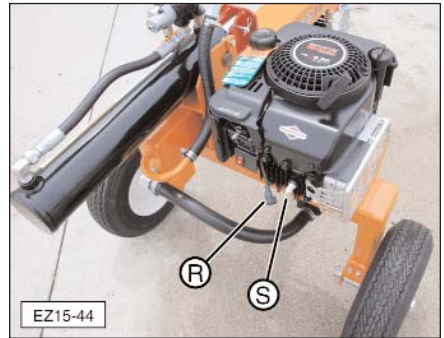

- b. Loosen clamp (E) and disconnect return hose (F) from the hydraulic tank and place it in a waste oil container (Please properly dispose of the waste oil per local regulations).

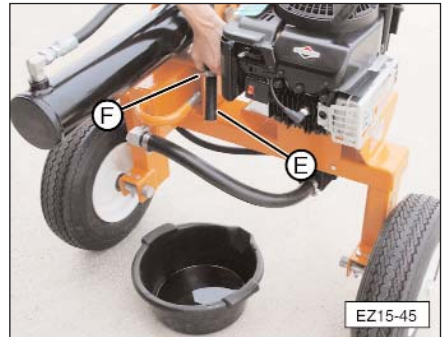

- c. Extend the cylinder. Hold valve handle (I) forward and pull on engine's pull start cord (T) to extend the cylinder until oil from the return line stops flowing. This step drains the head end of the cylinder.

NOTE: Do not re-attach low-pressure hose (F) at this time.

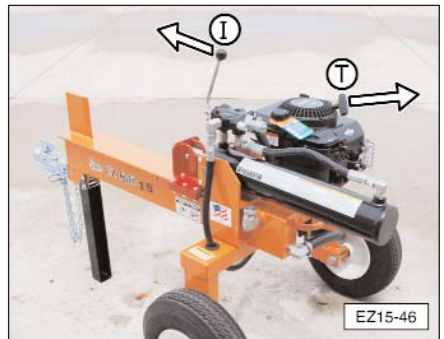

Important Notice

DO NOT mix tractor hydraulic oil with transmission fluid. Use one or the other.

3. Remove the fill cap and oil level screw and SLOWLY pour oil into oil fill opening (K) until it runs from oil level hole (L). Reinstall fill cap and oil level screw making sure O-rings are in place.

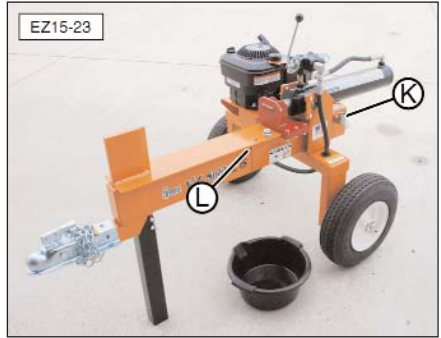

4. Drain and fill the piston end of the cylinder.

- a. Place the end of return hose (F) removed in Step 2b over a container. Hold valve handle (I) in the retract position, and pull engine pull start cord (T) until the rod is fully retracted. This step pushes the old oil from the piston end of the cylinder.
- b. Reconnect return hose (F) to the oil tank, and tighten clamp (E).
- c. Extend the cylinder. Hold valve handle (I) forward and pull on engine's pull start cord (T) until the cylinder is completely extended. This step refills the piston end of the hydraulic cylinder.

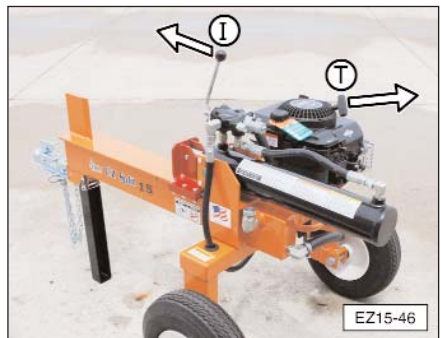
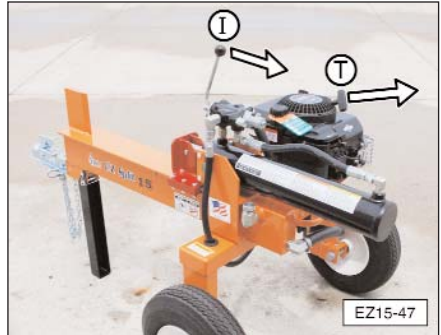

Inspection and Maintenance

5. Start the engine and cycle the cylinder.
 - a. Replace the spark plug and spark plug wire.
 - b. Start the engine and use control lever (I) to cycle (extend and retract) the hydraulic cylinder several times.
 - c. Fully retract the cylinder and shut off the engine.

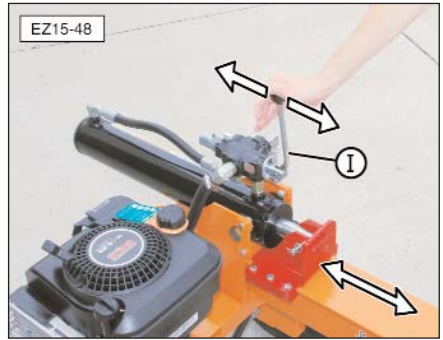

- d. Allow the log splitter to cool for a few minutes to relieve pressure before checking the hydraulic oil level. Remove the fill cap and oil level screw and SLOWLY pour oil into oil fill opening (K) until it runs from oil level hole (L). Re-install fill cap and oil level screw making sure O-rings are in place.

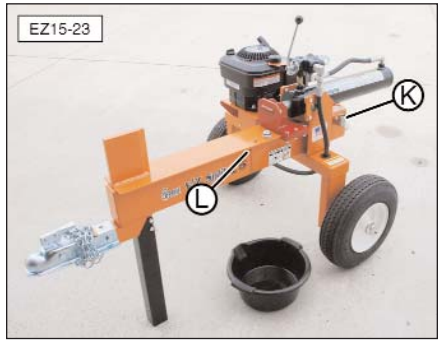

Tire Pressure

Check the EZ Split 15 tire pressure on a regular basis and before towing. Set the air pressure in both tires to the tire manufacturers' specifications, molded into the sidewall of each tire.



Mechanical Specifications

Slide Rail	2.5 x 5 inch (63.5 x 127 mm) reinforced, heavy-duty, steel tube
Wedge	High carbon steel, 3/4" inch (19.05 mm) thick
Force/Tonnage	15 tons (13.6 tonne)
Cylinder Stroke	18 inches (45.7 cm)
Log Opening	19 inch (48.3 cm) maximum
Engine	Standard 4-cycle vertical shaft engine
Coupling Size (Hitch Ball)	.2 inch (50.8 mm)
Tire Size	.4.80 x 8 inch

Hydraulic Specifications

Hydraulic Cylinder	3.5 x 18 inch (8.9 x 47.5 cm) trunnion mount with 1.5 in (3.8 cm) piston rod
Hydraulic System Capacity (including cylinder, tank, and hoses)	. 9 quarts (8.5 liters)
Safety Release Control Valve	Detent, auto return
Gear Pump	two-stage, 11 GPM (41.6 LPM)
Shipping Weight	317 lbs (144 kg)
Operating Weight	240 lbs (109 kg)

Hydraulic Oil Specifications (non foaming)

- For extremely cold weather conditions SAE 10W Tractor Hydraulic Oil
or Dexron III Transmission Fluid
- For extremely warm weather conditions SAE 30W Tractor Hydraulic Oil

Important Notice

DO NOT mix tractor hydraulic oil with transmission fluid. Use one or the other.

Troubleshooting

The following section details procedures for checking your log splitter, should you encounter a malfunction. Brave Products, Inc. recommends that you do not attempt to make repairs to the log splitter. In the long run, it is better to take your log splitter to a servicing lawn and garden dealer for repairs.

Problem: When the control handle is pushed forward (extend), the pusher plate does not move.

1. Check the hydraulic tank to make sure the oil level is correct.
2. Remove the pump from the engine flange. Check the coupler, making sure the drive keys are in place and there is no damage to the urethane spider.
3. Disconnect the pusher plate from the cylinder. Grasp the hydraulic cylinder shaft and try to pull it out. If the rod comes out easily, you will need to rebuild or replace the cylinder.
4. Once you have determined that the engine-to-pump coupler is intact and the cylinder is in good condition, you will need to replace the pump.

Problem: The engine stalls when the pusher plate engages the wood.

1. The engine may not be properly adjusted. Take the engine to a service center for repair and/or adjustment.
2. If all engine settings are correct, replace the pump.

Problem: The pusher plate moves slowly, but will split wood.

1. Check the oil level in the hydraulic tank and fill if necessary.
2. Check the high-pressure hose, fittings, and valve openings for dirt and debris that may have obstructed the openings.
3. If the ram speed is still slow, replace the pump.

Problem: The ram will not automatically retract.

1. Check the slide rail or pusher plate for damage.
2. Push the valve handle to the retract position. If the handle will not stay in this position, contact the factory.



Make sure all decals are attached to the log splitter and/or engine and are legible at all times. If you are missing a decal or one is not legible, call Brave Products at 800-350-8739 for a replacement.

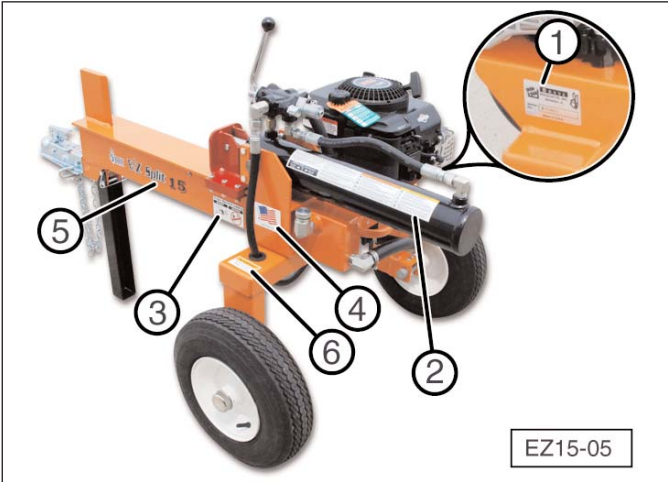

Item	Part No.	Description	Qty.
1	BR002521	Decal, Serial Number	1
2	BR002301	Decal, Operator Safety	1
3	BR002560	Decal, Proper Machine Loading	1
4	BR002621	Decal, Made in the U.S.A.	1
5	BR002305	Decal, EZ Split 15 Logo	2
6	BR002653	Decal, Maximum Speed	1

(1) BR002521



(2) BR002301

E-Z SPLIT OPERATING INSTRUCTIONS / INSTRUCCIONES OPERATIVAS	
<p>1. Read Owner/Operator manual for complete instructions. Lea el manual del propietario/operario para ver todas las instrucciones.</p> <p>2. Start engine using instructions from engine manual. Advance throttle control to maximum speed. Ponga en marcha la máquina según el manual del motor. Lleve el regulador a la velocidad máxima.</p>	<p>3. Grab log by sides and place onto rail, against base plate. Tome el tronco por los lados y colóquelo sobre el riel, contra la base de apoyo.</p> <p>4. If necessary, stabilize log by holding the side, never the end. Si es necesario, estabilice el tronco tomándolo de un costado, no del extremo.</p> <p>5. Move control handle to FORWARD position to extend cylinder. Mueva la manivela de control en ADELANTE para alargar el cilindro.</p> <p>6. Release handle to STOP the cylinder. Libere la manivela para DETENER el cilindro.</p> <p>7. Move control handle to REVERSE position to retract cylinder. Coloque la manivela de control en REVERSO para retraer el cilindro.</p>
<div style="border: 1px solid black; padding: 5px; background-color: black; color: white;"> <p style="text-align: center; font-weight: bold;">CONTROL VALVE / Válvula de control</p> <div style="display: flex; justify-content: space-around; align-items: center;"> <div style="text-align: center;"> <p style="font-size: 2em;">▶</p> <p style="font-weight: bold; color: white;">Forward Adelante</p> </div> <div style="text-align: center;"> <p style="font-size: 1.5em;">■</p> <p style="font-weight: bold; color: white;">Neutral Neutro</p> </div> <div style="text-align: center;"> <p style="font-size: 2em;">◀</p> <p style="font-weight: bold; color: white;">Reverse Reverso</p> </div> </div> </div>	
<p>Keep hands and feet off the log splitter base plate. Mantenga las manos y los pies fuera de la base de apoyo.</p> <p>Hold logs by the sides, not the ends. Tome los troncos por los lados, no por los extremos.</p> <p>Only one person is permitted to stabilize logs and operate the controls. Solo una persona debe estabilizar los troncos y operar los controles.</p> <p>Do not check for oil leaks with your hand. Use a cloth. High pressure hydraulic fluid can penetrate your skin causing blood poisoning. No utilice la mano para ver si hay pérdidas de aceite. Use un paño. El fluido hidráulico con alta presión puede penetrar la piel y provocar un envenenamiento.</p> <p>Never operate log splitter under the influence of alcohol or drugs. Nunca opere la cortadora de troncos si ha bebido o tomado drogas.</p>	
<p>Keep hands and feet off the log splitter base plate. Mantenga las manos y los pies fuera de la base de apoyo.</p> <p>Hold logs by the sides, not the ends. Tome los troncos por los lados, no por los extremos.</p> <p>Only one person is permitted to stabilize logs and operate the controls. Solo una persona debe estabilizar los troncos y operar los controles.</p> <p>Do not check for oil leaks with your hand. Use a cloth. High pressure hydraulic fluid can penetrate your skin causing blood poisoning. No utilice la mano para ver si hay pérdidas de aceite. Use un paño. El fluido hidráulico con alta presión puede penetrar la piel y provocar un envenenamiento.</p> <p>Never operate log splitter under the influence of alcohol or drugs. Nunca opere la cortadora de troncos si ha bebido o tomado drogas.</p>	
<p>Keep hands and feet off the log splitter base plate. Mantenga las manos y los pies fuera de la base de apoyo.</p> <p>Hold logs by the sides, not the ends. Tome los troncos por los lados, no por los extremos.</p> <p>Only one person is permitted to stabilize logs and operate the controls. Solo una persona debe estabilizar los troncos y operar los controles.</p> <p>Do not check for oil leaks with your hand. Use a cloth. High pressure hydraulic fluid can penetrate your skin causing blood poisoning. No utilice la mano para ver si hay pérdidas de aceite. Use un paño. El fluido hidráulico con alta presión puede penetrar la piel y provocar un envenenamiento.</p> <p>Never operate log splitter under the influence of alcohol or drugs. Nunca opere la cortadora de troncos si ha bebido o tomado drogas.</p>	

WARNING / ADVERTENCIA	CAUTION / PRECAUCIÓN
<p>Keep hands and all body parts away from splitting wedge, base plate, and fully split wood, and moving parts. Mantenga las manos y todas las partes del cuerpo alejadas del cabezal de corte, la base de apoyo, la madera cortada parcialmente y las piezas móviles.</p> <p>Hold logs by the sides, not the ends. Tome los troncos por los lados, no por los extremos.</p> <p>Only one person is permitted to stabilize logs and operate the controls. Solo una persona debe estabilizar los troncos y operar los controles.</p> <p>Do not check for oil leaks with your hand. Use a cloth. High pressure hydraulic fluid can penetrate your skin causing blood poisoning. No utilice la mano para ver si hay pérdidas de aceite. Use un paño. El fluido hidráulico con alta presión puede penetrar la piel y provocar un envenenamiento.</p> <p>Never operate log splitter under the influence of alcohol or drugs. Nunca opere la cortadora de troncos si ha bebido o tomado drogas.</p>	<p>Read Owner/Operator manual completely. Lea todo el manual del propietario/operario.</p> <p>Operate log splitter on flat, dry ground. La cortadora de troncos debe estar sobre suelo firme y seco.</p> <p>NO ONE under age 18 is allowed to operate log splitter. NADIE menor de 18 años está autorizado a utilizar la cortadora de troncos.</p> <p>Keep bystanders, children, and helpers at least 25 ft. away. No permita que observadores, niños y ayudantes se acerquen más de 25 pies-7,6m.</p> <p>Wear safety glasses, tight fitting work gloves, and safety shoes. Use lentes de seguridad, guantes de trabajo ajustados y zapatos de seguridad.</p>

(3) BR002560

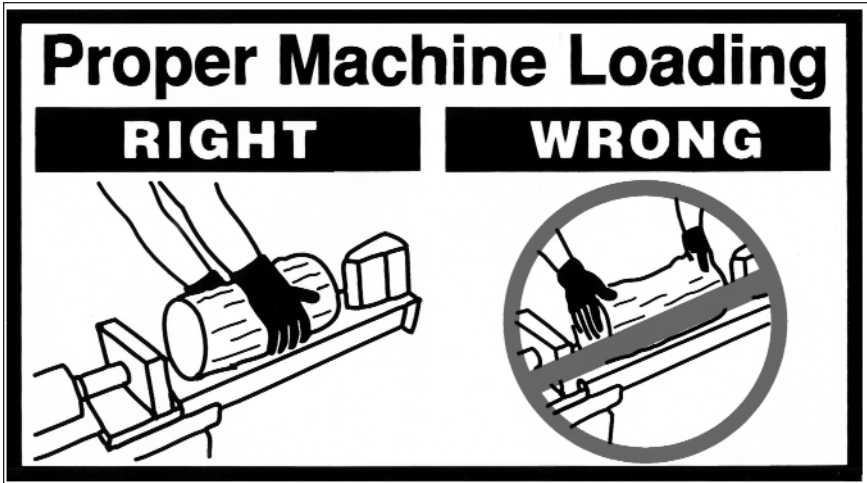

(4) BR002621



Decals

(5) BR002305

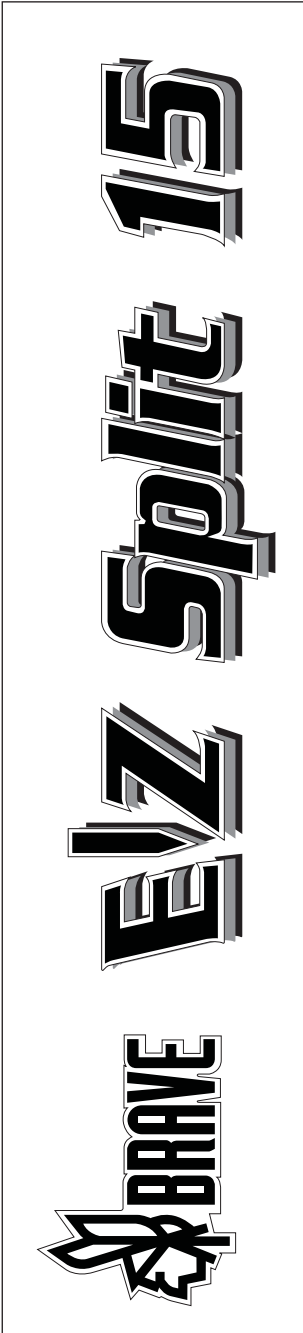

(6) BR002653



Safety Flag Kit (BR012105)

- ✓ Improves visibility of logsplitter when towing.
- ✓ Heavy-duty tapered fiberglass pole won't bend over at towing speeds.
- ✓ Installs in minutes, no drilling required.
- ✓ Mounting instructions included.



Parts

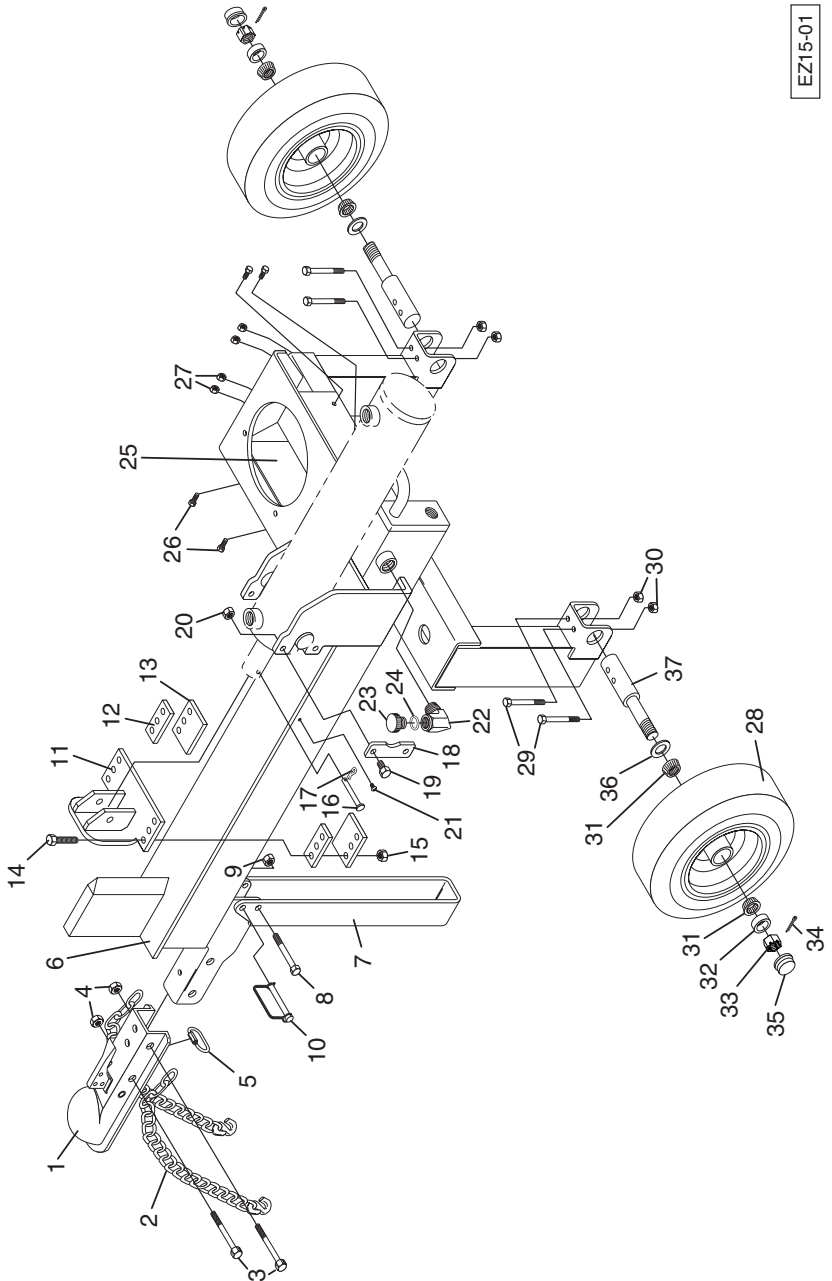

EZ15-01

Item	Part No.	Description	Qty	Item	Part No.	Description	Qty
1	BR008540	Hitch Coupler	1	22	BR001098	Fitting, Street Elbow	1
2	BR008508	Safety Chain	2	23	BR001021-V	Cap, Oil Fill	1
3	BR001201	Bolt, 1/2-13 x 3.5 inch long	2	24	BR001025	Rubber O-ring	1
4	BR001321	Locknut, 1/2-13	2	25	BR015125	Cover Plate	2
5	BR008511	Quick Link	1	26	BR001232	Bolt, 1/4-20 x 3/4 inch long	4
6	BR015101	Rail/Tank Weldment	1	27	BR001306	Locknut, 1/4-20	4
7	BR015118	Front Leg	1	28	BR008301	Tire/Wheel Assembly	2
8	BR001218	Bolt, 3/8-16 x 3 inch long	1	29	BR001218	Bolt, 3/8-16 x 3 inch long	4
9	BR001301	Locknut, 3/8-16	1	30	BR001301	Locknut, 3/8-16	4
10	BR001770	Snap Lockpin, 5/16 x 3 inch long	1	31	BR008301A	Wheel Bearing	4
11	BR015103	Slide Weldment	1	32	BR008301D	Washer, 3/4 inch	2
12	BR015122	Slide Guide Plate	2	33	BR008301E	Spindle Nut	2
13	BR015123	Slide Retainer Plate	2	34	BR008310F	Cotter Key, 1/8 x 2 inch	2
14	BR001251	Bolt, 3/8-16 x 1.5 inch long	6	35	BR008301G	Dust Cap	2
15	BR001301	Locknut, 3/8-16	6	36	BR008301B	Grease Seal	2
16	BR001765	Cylinder Pin	1	37	BR008101	Spindle (axle shaft)	2
17	BR001761	Hairpin Clip, 3/32 x 1-5/8 inch long	1			Not Shown	
18	BR015124	Cylinder Retainer Plate	2	—	BR002804	EZ Split 15 Manual	1
19	BR001198	Bolt, 3/8-16 x 1 inch long	4	—	BR002802	Engine Manual	1
20	BR001301	Locknut, 3/8-16	4				
21	BR001292	Screw, Oil Level	1				

Item	Part No.	Description	Qty	Item	Part No.	Description	Qty
1	BR004101A	Handle Assembly Kit (includes handle, clevis pins, and hairpin clips)	1	19	BR006002E	Engine Coupling	1
2	BR004100	Control Valve	1	20	BR006002B	Coupling Spider	1
3	BR001052	Fitting, Straight	1	21	BR006002A	Pump Coupling	1
4	BR004002K	Fitting, 90 Degree Elbow	2	22	BR001383	Set Screw, 1/4-20 x 1/2 inch	2
5	BR005091	High-Pressure Hose (cylinder to bottom of valve)	1	23	BR002001MK	Pump Shaft Key	1
6	BR001011	Fitting, 90 Degree Elbow	1	24	BR002003	Hydraulic Pump, 11 gpm	1
7	BR001017	Fitting, 90 Degree Elbow	1	25	BR001269	Bolt, 5/16-18 x 5.5 inch long	2
8	BR005088	High-Pressure Hose (pump to valve)	1	26	BR001325	Locknut, 5/16-18	2
9	BR004071	Hydraulic Cylinder	1	27	BR001079	Fitting, 90 Degree Elbow	1
10	BR005085	Low-Pressure Hose (valve to tank)	1	28	BR005085	Low-Pressure Hose (tank to pump inlet)	1
11	BR005001	Hose Clamp, #12	2	29	BR004999	Hose Clamp, #16	2
12	—	Engine	1	30	BR001007	Fitting, 90 Degree Elbow	1
13	BR001270	Bolt, 5/16-18 x 2.5 inch long	1	31	BR001032	Rubber Grommet	1
14	BR001268	Bolt, 5/16-18 x 1.5 inch long	2				
15	BR001325	Locknut, 5/16-18	3				
16	BR001401	Washer, 5/16 inch	2				
17	BR001405	Washer, 1/4 inch	1				
18	BR010104	Square Key, 3/6 x 1 inch	1				

Note: When replacing item 24 - Hydraulic Pump, all four pump bolts must be tightened to 13.5 ft. lbs (18.3 N-m).

Warranty

For one year from the date of purchase, Brave Products Inc. will replace for the original purchaser, or repair free of charge, all parts of the Brave Products' Hydraulic Log Splitter, returned to our factory PREPAID and found upon inspection by us to be faulty, due to defects in materials or workmanship.

The warranty shall not apply to any unit which has been overloaded or misused or which has been used or operated contrary to our instructions, or which has been repaired or altered by anyone other than our authorized representative.

We shall not be liable for any contingent liabilities arising out of the improper function of any parts.

We make NO WARRANTY with respect to parts NOT of our manufacture, but we will carry out the terms of the warranties of their respective manufacturers.

For commercial and rental use, the warranty period is for 30 days from date of purchase.

If you need any support for this product, please call Brave Products at (800) 350-8739. Have your model and serial number on-hand before calling.

Important Warranty Information

To activate your Brave Products' log splitter warranty, please fill out the information in the form below, copy this page or clip out the form on the dotted line, insert into an envelope, and mail to:

Brave Products, Inc
1705 N. Shabbona St.
Streator, IL 61364-1301

Brave Products' Log Splitter Warranty Information - Please Print -

Model: PCLS15 SERIAL #: _____

OWNER'S NAME: _____

ADDRESS: _____

CITY: _____ STATE: _____ ZIP: _____

Purchased From: _____

Street Address: _____

City: _____ State: _____ Zip: _____

Your Signature: _____ Date: _____

Notes

Notes



Brave Products, Inc.
1705 N. Shabbona St.
Streator, Illinois 61364-1301
Phone: 800-350-8739 Fax: 815-672-9073
E-mail: sales@braveproducts.com
Web Site: www.braveproducts.com